

PORTE BLINDATE





Con porta blindata si intende un serramento fornito di particolari caratteristiche antiscasso, resistente ai tentativi di effrazione.

indice

porte blindate

yard	4
classic	6
energy	8
energy 2	10
power 105	12
power 105 2	14
sortie	16
sortie 2	18

pannelli

pantografati	20
serigrafati	32
linea 3000	42
alluminio	46
massello	56
antine	62
pannelli lisci	64
cornici	68
svetratura	70

accessori	76
-----------	----

Le immagini sono fornite al solo scopo illustrativo e non costituiscono elemento contrattuale.
L'azienda si riserva di cambiare in qualsiasi momento caratteristiche e misure dei prodotti ivi contenute.

Yard

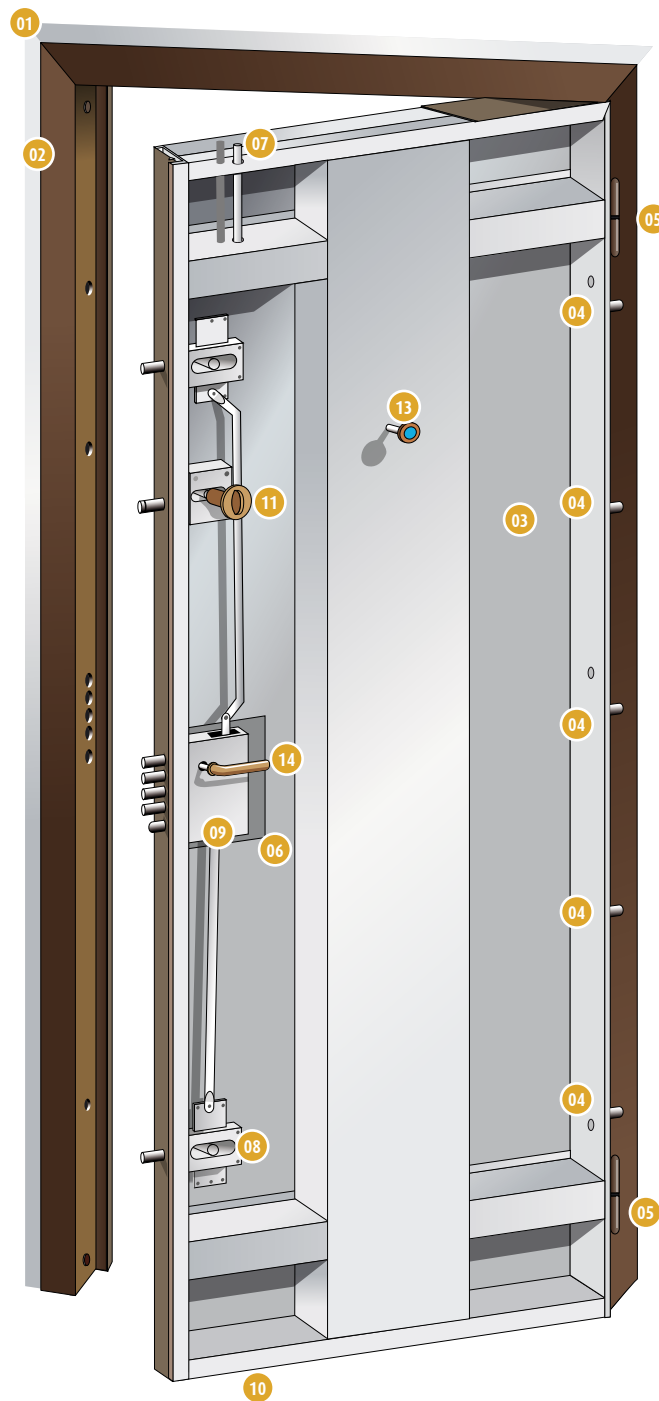

- 1 Falso telaio in lamiera d'acciaio zincato
- 2 Telaio in lamiera d'acciaio plastificato
- 3 Battente in lamiera d'acciaio zincato
- 4 Rostri
- 5 Cerniere
- 6 Piastra
- 7 Paletto
- 8 Deviatore singolo
- 9 Serratura di sicurezza a cilindro europeo
- 10 Soglia mobile paraspifferi
- 11 Limitatore d'apertura
- 12 Pomolo esterno
- 13 Spioncino grandangolare 200°
- 14 Maniglia interna
- 15 Pannelli lisci

DIMENSIONI

Luce	Maxingombro falso telaio
80x210	92,5x216,5
85x210	97,5x216,5
90x210	102,5x216,5

Non disponibile in fuori misura

CARATTERISTICHE TECNICHE E DOTAZIONI DI SERIE

Falso telaio in lamiera d'acciaio zincato
spessore 20/10 con distanziali, n°8 zanche a murare, cavallotti di registrazione e piastre di fissaggio.

Telaio in lamiera d'acciaio plastificato
spessore 20/10 plastificato bifacciale colore testa di moro antiruggine con guarnizione di battuta e pellicola protettiva.

Battente in lamiera d'acciaio zincato
n° 1 omega centrale verticale di rinforzo, n° 2 omega orizzontali di rinforzo inferiore e superiore per fissaggio cerniere.

Rostri
n°5, fissi in acciaio lato cerniera

Cerniere
n°2 in acciaio zincato antiruggine, perno a sfera 14x58, gommino a soffietto, copri cerniere in PVC colore testa di moro con tappi, registrabili in H / L.

Piastra
in lamiera d'acciaio, spessore 30/10 a protezione serratura

Paletto
singolo di chiusura superiore con pistone in acciaio.

Deviatore
singolo di chiusura inferiore con pistone in acciaio.

Serratura di sicurezza a cilindro europeo
con 4 pistoni più scrocco.

Cilindro Europeo
con n° 5 chiavi + n° 1 da cantiere + scheda.

Soglia mobile paraspifferi
automatica

Limitatore d'apertura

Pomolo esterno
in alluminio bronzato (optional maniglia girevole)

Spioncino grandangolare 200°
in alluminio bronzato

Maniglia interna
in alluminio bronzato

Pannelli lisci
interno ed esterno di serie standard.

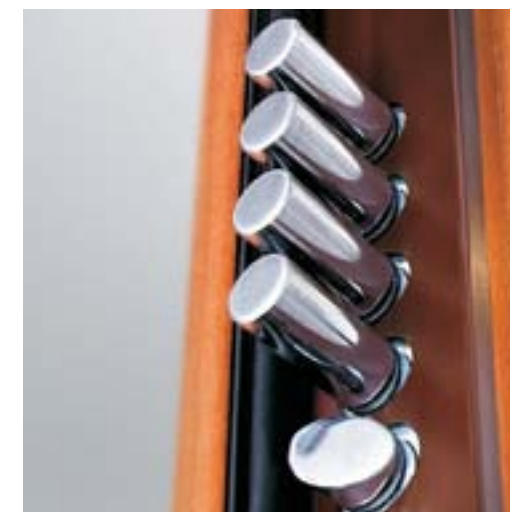

Serratura



Kit bronzato



Mono deviatore

Classic

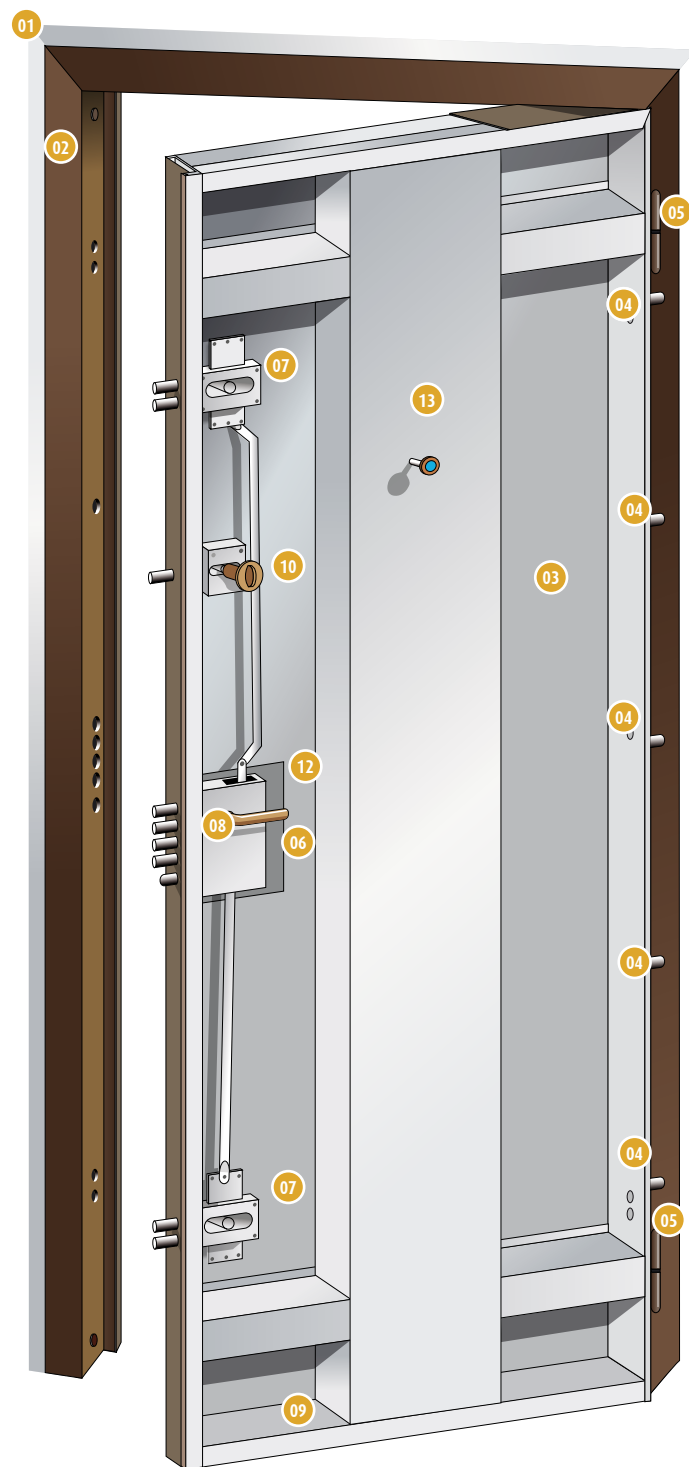

- 1 Falso telaio in lamiera d'acciaio zincato
- 2 Telaio in lamiera d'acciaio plastificato
- 3 Battente in lamiera d'acciaio zincato
- 4 Rostri
- 5 Cerniere
- 6 Piastra
- 7 Doppio deviatore
- 8 Serratura di sicurezza a cilindro europeo
- 9 Soglia mobile paraspifferi
- 10 Limitatore d'apertura.
- 11 Pomolo esterno
- 12 Maniglia interna
- 13 Spioncino grandangolare 200°
- 14 Pannello liscio

DIMENSIONI

Luce	Maxingombro falso telaio
80x210	92,5x216,5
85x210	97,5x216,5
90x210	102,5x216,5

Non disponibile in fuori misura

CARATTERISTICHE TECNICHE E DOTAZIONI DI SERIE

Falso telaio in lamiera d'acciaio zincato
spessore 20/10 con distanziali, n°8 zanche a murare, cavallotti di registrazione e piastre di fissaggio.

Telaio in lamiera d'acciaio plastificato
spessore 20/10 plastificato bifacciale colore testa di moro antiruggine con guarnizione di battuta e pellicola protettiva.

Battente in lamiera d'acciaio zincato
con n° 1 omega centrale verticale di rinforzo, n° 2 omega orizzontali di rinforzo inferiore e superiore per fissaggio cerniere.

Rostrì
n°5, fissi in acciaio lato cerniera

Cerniere
n°2 in acciaio zincato antiruggine, perno a sfera 14x58, gommino a soffiato, copri cerniere in PVC colore testa di moro con tappi, registrabili in H / L.

Piastra
in lamiera d'acciaio 30/10 a protezione serratura.

Doppio deviatore
di chiusura inferiore con pistone in acciaio.

Serratura di sicurezza a cilindro europeo
a cilindro europeo con 4 pistoni più scrocco.

Cilindro Europeo
con n° 5 chiavi + n° 1 da cantiere + scheda.

Soglia mobile paraspifferi
automatica.

Limitatore d'apertura.

Pomolo esterno
in alluminio bronzato (optional maniglia girevole)

Maniglia interna
in alluminio bronzato.

Spioncino grandangolare 200°
in alluminio bronzato.

Pannello liscio
interno ed esterno di serie standard.

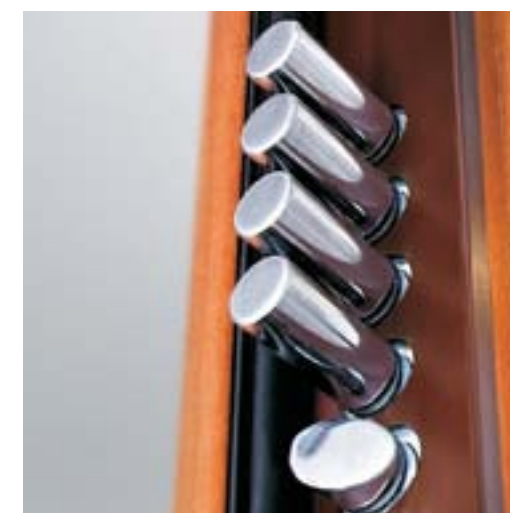

Serratura



Kit bronzato

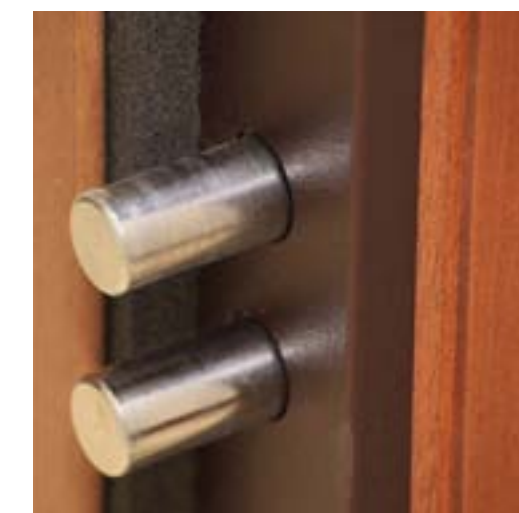

Particolare doppio deviatore

Energy

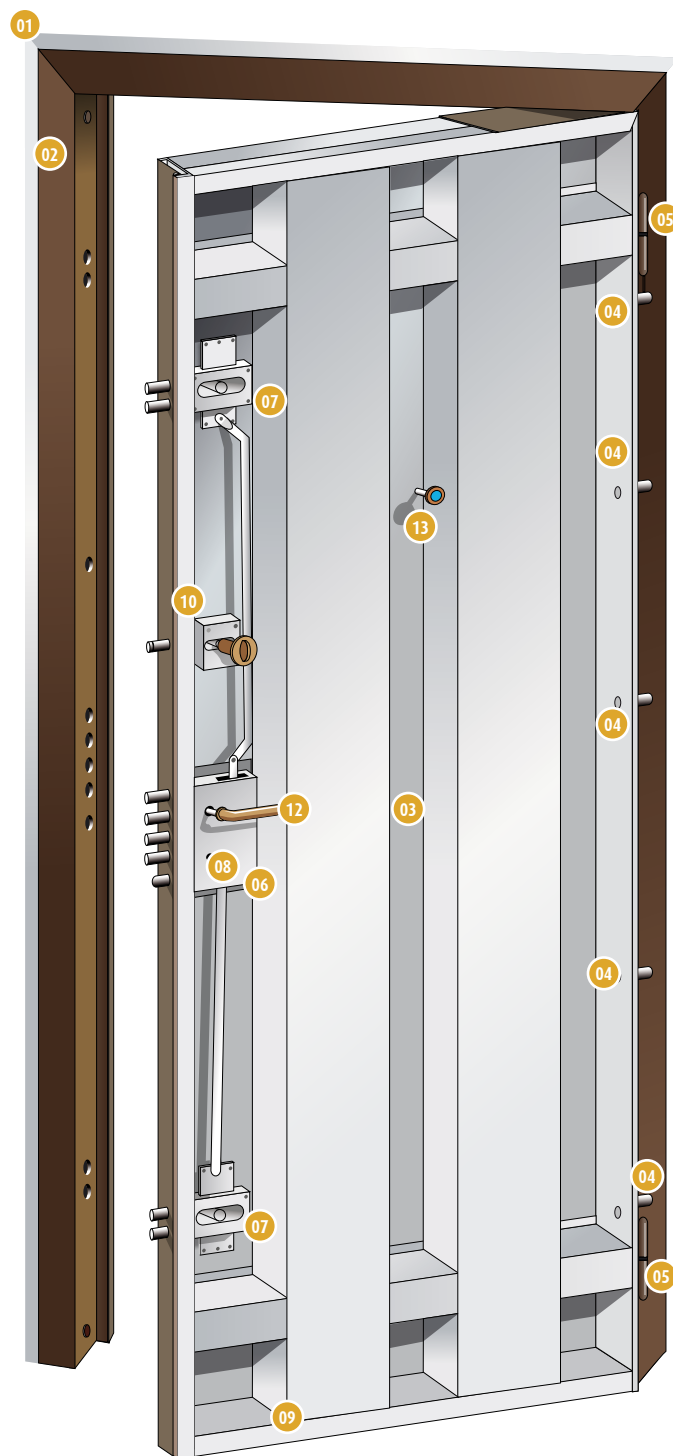

- 1 Falso telaio in lamiera d'acciaio zincato
- 2 Telaio in lamiera d'acciaio plastificato
- 3 Battente in lamiera d'acciaio zincato
- 4 Rostri
- 5 Cerniere
- 6 Piastra
- 7 Doppio deviatore
- 8 Serratura di sicurezza a cilindro europeo
- 9 Soglia mobile paraspifferi
- 10 Limitatore d'apertura
- 11 Pomolo esterno
- 12 Maniglia interna
- 13 Spioncino grandangolare 200°
- 14 Pannello liscio
- 15 Kit cornice perimetrale

DIMENSIONI

Luce	Maxingombro falso telaio
80x210	92,5x216,5
85x210	97,5x216,5
90x210	102,5x216,5

Disponibile in fuori misura

CARATTERISTICHE TECNICHE E DOTAZIONI DI SERIE

Falso telaio in lamiera d'acciaio zincato
spessore 20/10 con distanziali, n°8 zanche a murare, cavallotti di registrazione e piastre di fissaggio.

Telaio in lamiera d'acciaio plastificato
spessore 20/10 plastificato bifacciale colore testa di moro antiruggine con guarnizione di battuta e pellicola protettiva.

Battente in lamiera d'acciaio zincato
con n° 2 omega centrale verticale di rinforzo, n° 2 omega orizzontali di rinforzo inferiore e superiore per fissaggio cerniere.

Rostri
n°5, fissi in acciaio lato cerniera

Cerniere
n°2 in acciaio zincato antiruggine, perno a sfera 14x58, gommino a soffiato, copri cerniere in PVC colore testa di moro con tappi, registrabili in H / L.

Piastra
in lamiera d'acciaio 30/10 a protezione serratura.

Doppio Deviatore
di chiusura inferiore con pistone in acciaio.

Serratura di sicurezza a cilindro europeo
a cilindro europeo con 4 pistoni più scrocco.

Cilindro Europeo
con n° 5 chiavi + n° 1 da cantiere + scheda.

Soglia mobile paraspifferi
automatica.

Limitatore d'apertura

Pomolo esterno
in alluminio colore ottone lucido. (optional maniglia girevole)

Maniglia interna
in alluminio colore ottone lucido.

Spioncino grandangolare 200°
in alluminio, colore ottone lucido.

Pannello liscio
interno ed esterno di serie standard

Kit cornice perimetrale
in legno a colore del pannello

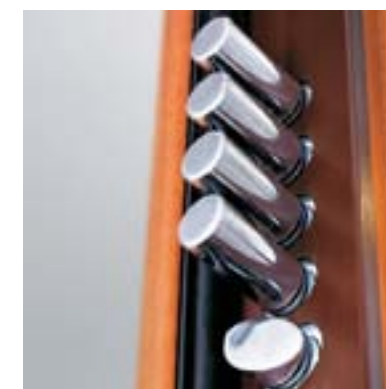

Serratura

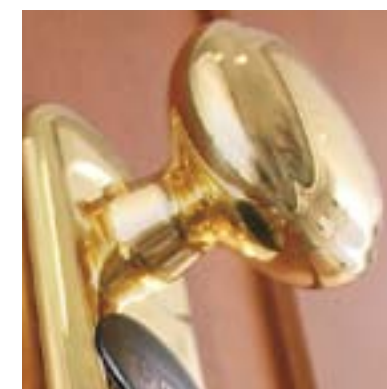

Kit ottone



Doppia omega



Kit cornice in legno

Energy 2

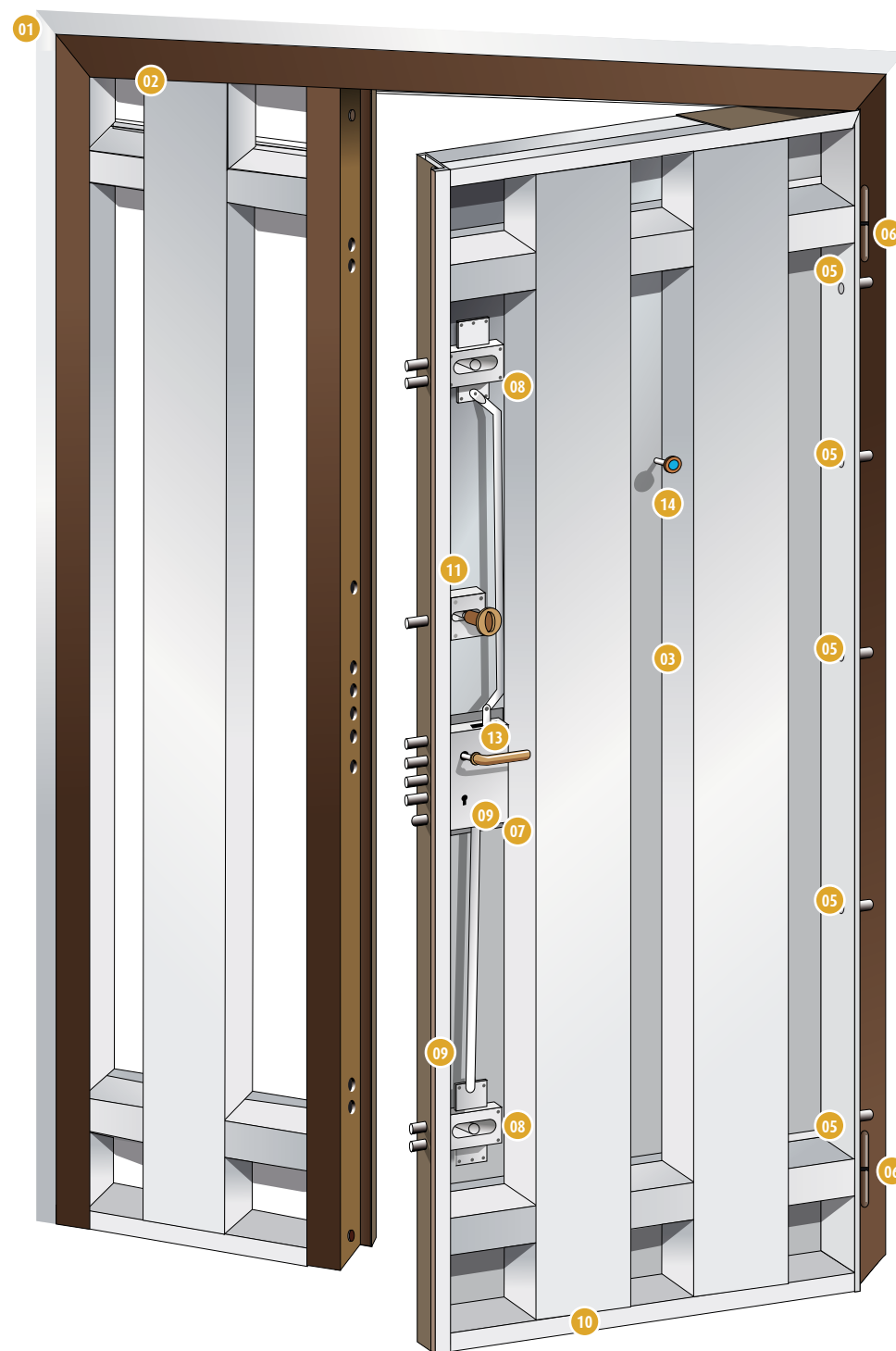

- 1 Falso telaio in lamiera d'acciaio zincato
- 2 Telaio in lamiera d'acciaio plastificato
- 3 Battente in lamiera d'acciaio zincato
- 4 Battente semifisso
- 5 Rostri
- 6 Cerniere
- 7 Piastra
- 8 Doppio deviatore
- 9 Serratura di sicurezza a cilindro europeo
- 10 Soglia mobile paraspifferi
- 11 Limitatore d'apertura.
- 12 Pomolo esterno
- 13 Maniglia interna
- 14 Spioncino grandangolare 200°
- 15 Pannello liscio
- 16 Kit cornice perimetrale

DIMENSIONI

Luce	Maxingombro falso telaio
110x210	122,5x216,5
115x210	127,5x216,5
120x210	132,5x216,5

Disponibile in fuori misura

CARATTERISTICHE TECNICHE E DOTAZIONI DI SERIE

Falso telaio in lamiera d'acciaio zincato
spessore 20/10 con distanziali, n°8 zanche a murare, cavallotti di registrazione e piastre di fissaggio.

Telaio in lamiera d'acciaio plastificato
spessore 20/10 plastificato bifacciale colore testa di moro antiruggine con guarnizione di battuta e pellicola protettiva.

Battente in lamiera d'acciaio zincato
con n° 2 omega centrale verticale di rinforzo, n° 2 omega orizzontali di rinforzo inferiore e superiore per fissaggio cerniere.

Battente semifisso
in lamiera d'acciaio zincato con n° 2 omega centrale verticale di rinforzo, n° 2 omega orizzontali di rinforzo inferiore e superiore per fissaggio cerniere, paletti di chiusura superiore su telaio ed inferiore a pavimento con vaschetta + chiavetta di apertura

Rostri
n°5, fissi in acciaio lato cerniera

Cerniere
n°4 in acciaio zincato antiruggine, perno a sfera 14x58, gommino a soffiato, copri cerniere in PVC colore testa di moro con tappi, registrabili in H / L.

Piastra
in lamiera d'acciaio 30/10 a protezione serratura.

Doppio Deviatore
di chiusura inferiore con pistone in acciaio.

Serratura di sicurezza a cilindro europeo
a cilindro europeo con 4 pistoni più scrocco.

Cilindro Europeo
con n° 5 chiavi + n° 1 da cantiere + scheda.

Soglia mobile paraspifferi
automatica.

Limitatore d'apertura.

Pomolo esterno
in alluminio colore ottone lucido. (optional maniglia girevole)

Maniglia interna
in alluminio colore ottone lucido.

Spioncino grandangolare 200°
in alluminio, colore ottone lucido.

Pannello liscio
interno ed esterno di serie standard

Kit cornice perimetrale
in legno a colore del pannello

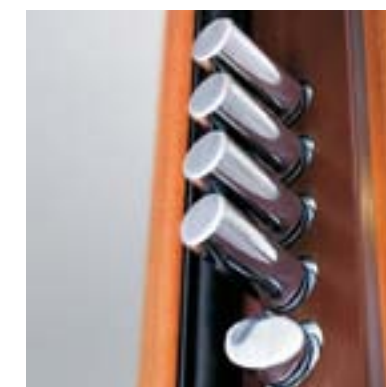

Serratura



Kit ottone



Doppia omega



Paletti di chiusura

Power 105

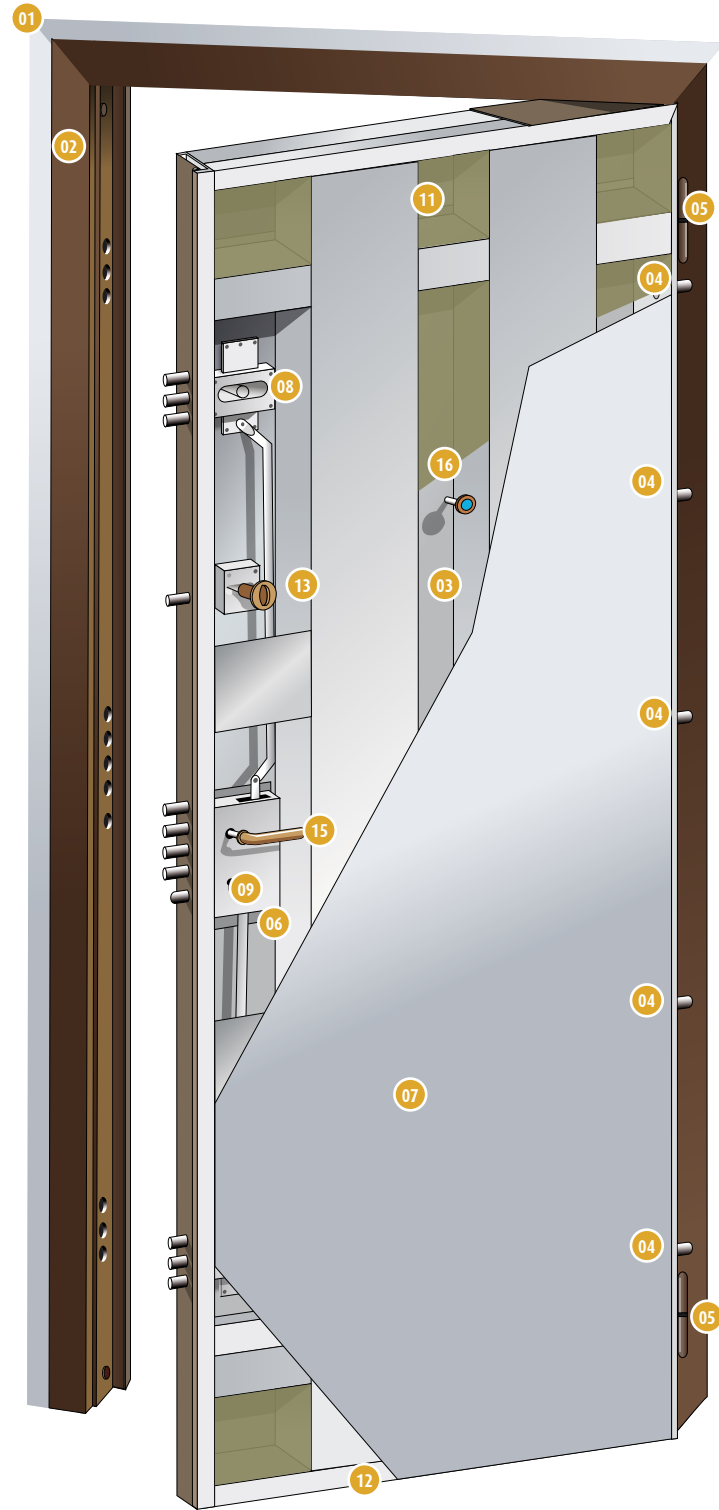

- 1 Falso telaio in lamiera d'acciaio zincato
- 2 Telaio in lamiera d'acciaio plastificato
- 3 Battente in lamiera d'acciaio zincato
- 4 Rostri
- 5 Cerniere
- 6 Piastra
- 7 Doppia lamiera
- 8 Triplice deviatore
- 9 Serratura di sicurezza a cilindro europeo
- 10 Defender antishock
- 11 Coibentazione in lana di roccia.
- 12 Soglia mobile paraspifferi
- 13 Limitatore d'apertura.
- 14 Pomolo esterno
- 15 Maniglia interna
- 16 Spioncino grandangolare 200°
- 17 Pannello liscio
- 18 Kit cornice perimetrale

DIMENSIONI

Luce	Maxingombro falso telaio
80x210	92,5x216,5
85x210	97,5 x 216,5
90x210	102,5 x 216,5

Disponibile in fuori misura

CARATTERISTICHE TECNICHE E DOTAZIONI DI SERIE

Falso telaio in lamiera d'acciaio zincato
spessore 20/10 con distanziali, n°8 zanche a murare, cavallotti di registrazione e piastre di fissaggio.

Telaio in lamiera d'acciaio plastificato
spessore 20/10 plastificato bifacciale colore testa di moro antiruggine con guarnizione di battuta e pellicola protettiva.

Battente in lamiera d'acciaio zincato
con n° 2 omega centrale verticale di rinforzo, n° 2 omega orizzontali di rinforzo inferiore e superiore per fissaggio cerniere.

Rostri
n°5, fissi in acciaio lato cerniera

Cerniere
n°2 in acciaio zincato antiruggine, perno a sfera 14x58, gommino a soffietto, copri cerniere in PVC colore testa di moro con tappi, registrabili in H / L.

Piastra
in lamiera d'acciaio 30/10 a protezione serratura.

Doppia lamiera
d'acciaio zincato lato interno

Triplice Deviatore
di chiusura inferiore con pistone in acciaio.

Serratura di sicurezza a cilindro europeo
a cilindro europeo con 4 pistoni più scrocco.

Cilindro Europeo
di sicurezza antibumping con n° 5 chiavi + n° 1 da cantiere + scheda.

Defender antishock

Coibentazione in lana di roccia.

Soglia mobile paraspifferi
automatica.

Limitatore d'apertura.

Pomolo esterno
in alluminio colore ottone lucido. (optional maniglia girevole)

Maniglia interna
in alluminio colore ottone lucido.

Spioncino grandangolare 200°
in alluminio, colore ottone lucido.

Pannello liscio
interno ed esterno di serie standard

Kit cornice perimetrale
in legno a colore del pannello

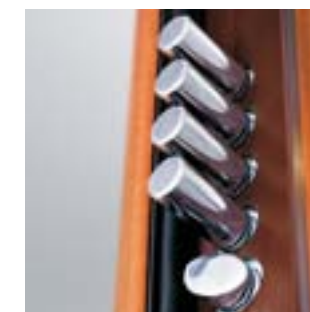

Serratura



Defender antishock

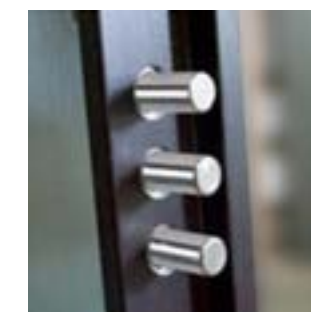

Particolare triplo deviatore



Kit cornice in legno

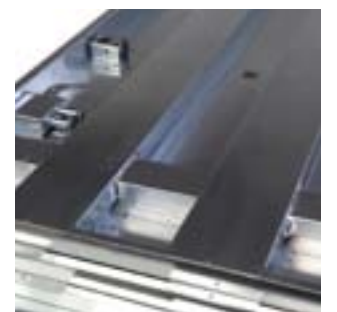

Doppia omega

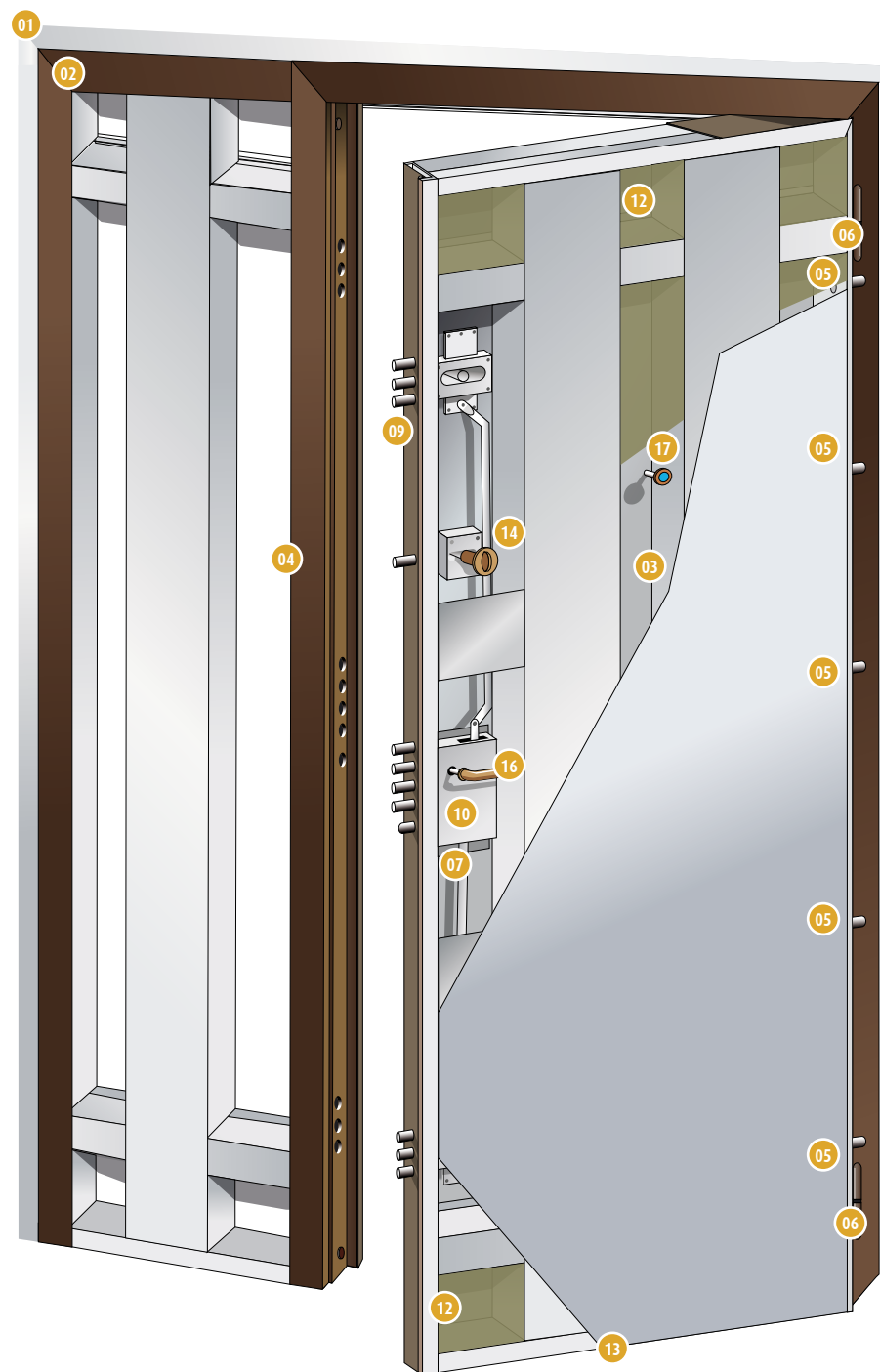

- 1 Falso telaio in lamiera d'acciaio zincato
- 2 Telaio in lamiera d'acciaio plastificato
- 3 Battente in lamiera d'acciaio zincato
- 4 Battente semifisso
- 5 Rostri
- 6 Cerniere
- 7 Piastra
- 8 Doppia lamiera
- 9 Triplice deviatore
- 10 Serratura di sicurezza a cilindro europeo
- 11 Defender antishock
- 12 Coibentazione in lana di roccia.
- 13 Soglia mobile paraspifferi
- 14 Limitatore d'apertura.
- 15 Pomolo esterno
- 16 Maniglia interna
- 17 Spioncino grandangolare 200°
- 18 Pannello liscio
- 19 Kit cornice perimetrale

DIMENSIONI

Luce	Maxingombro falso telaio
110 x 210	122,5 x 216,5
115 x 210	127,5 x 216,5
120 x 210	132,5 x 216,5

Disponibile in fuori misura

CARATTERISTICHE TECNICHE E DOTAZIONI DI SERIE

Falso telaio in lamiera d'acciaio zincato
spessore 20/10 con distanziali, n°8 zanche a murare, cavallotti di registrazione e piastre di fissaggio.

Telaio in lamiera d'acciaio plastificato
spessore 20/10 plastificato bifacciale colore testa di moro antiruggine con guarnizione di battuta e pellicola protettiva.

Battente in lamiera d'acciaio zincato
con n° 2 omega centrale verticale di rinforzo, n° 2 omega orizzontali di rinforzo inferiore e superiore per fissaggio cerniere.

Battente semifisso
in lamiera d'acciaio zincato con n° 2 omega centrale verticale di rinforzo, n° 2 omega orizzontali di rinforzo inferiore e superiore per fissaggio cerniere, paletti di chiusura superiore su telaio ed inferiore a pavimento con vaschetta + chiavetta di apertura

Rostri
n°5, fissi in acciaio lato cerniera

Cerniere
n°4 in acciaio zincato antiruggine, perno a sfera 14x58, gommino a soffietto, copri cerniere in PVC colore testa di moro con tappi, registrabili in H / L.

Piastra
in lamiera d'acciaio 30/10 a protezione serratura.

Doppia lamiera
d'acciaio zincato lato interno

Triplice Deviatore
di chiusura inferiore con pistone in acciaio.

Serratura di sicurezza a cilindro europeo
a cilindro europeo con 4 pistoni più scrocco.

Defender antishock

Cilindro Europeo
antibumping con n° 5 chiavi + n° 1 da cantiere + scheda.

Coibentazione in lana di roccia.

Soglia mobile paraspifferi
automatica.

Limitatore d'apertura.

Pomolo esterno
in alluminio colore ottone lucido. (optional maniglia girevole)

Maniglia interna
in alluminio colore ottone lucido.

Spioncino grandangolare 200°
in alluminio, colore ottone lucido.

Pannello liscio
interno ed esterno di serie standard

Kit cornice perimetrale
in legno a colore del pannello

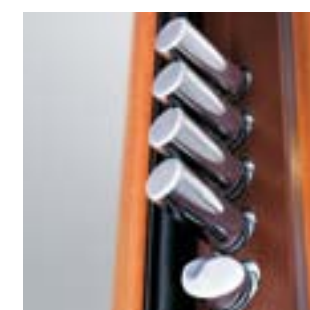

Serratura



Kit ottone

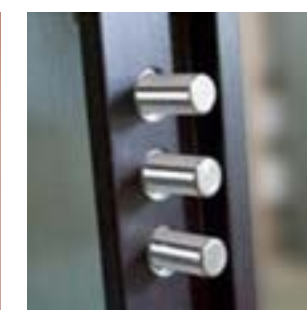

kit triplo deviatore



paletti di chiusura



Defender Antishock

Sortie

apertura verso l'esterno

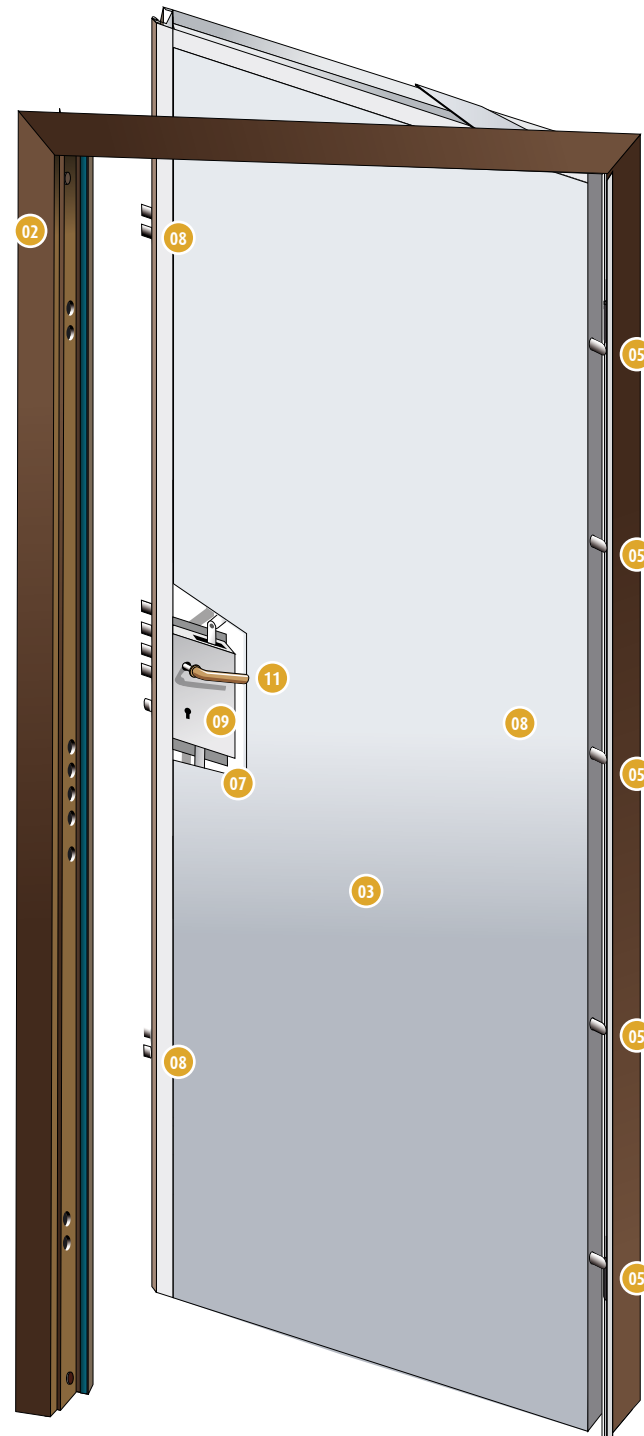

- 1 Falso telaio in lamiera d'acciaio zincato
- 2 Telaio in lamiera d'acciaio plastificato
- 3 Battente in lamiera d'acciaio zincato
- 4 Lamiera interna in acciaio zincato
- 5 Rostri
- 6 Cerniere
- 7 Piastra
- 8 Doppio deviatore
- 9 Serratura di sicurezza a cilindro europeo
- 10 Pomolo esterno
- 11 Maniglia interna
- 12 Spioncino grandangolare 200°
- 13 Pannello liscio

DIMENSIONI

Luce	Maxingombro falso telaio (Montaggio al contrario)
80x210	92,5x216,5
85x210	97,5 x 216,5
90x210	102,5 x 216,5

Disponibile in fuori misura

CARATTERISTICHE TECNICHE E DOTAZIONI DI SERIE

Falso telaio in lamiera d'acciaio zincato
spessore 20/10 con distanziali, n°8 zanche a murare, cavallotti di registrazione e piastre di fissaggio.

Telaio in lamiera d'acciaio plastificato
spessore 20/10 plastificato bifacciale colore testa di moro antiruggine con guarnizione di battuta e pellicola protettiva.

Battente in lamiera d'acciaio zincato
con n° 2 omega centrale verticale di rinforzo, n° 2 omega orizzontali di rinforzo inferiore e superiore per fissaggio cerniere.

Lamiera interna in acciaio zincato
per cablaggio serratura.

Rostri
n°5, fissi in acciaio lato cerniera

Cerniere
n°2 in acciaio zincato antiruggine, perno a sfera 14x58, gommino a soffiato, copri cerniere in PVC colore testa di

moro con tappi, registrabili in H / L.

Piastra
in lamiera d'acciaio 30/10 a protezione serratura.

Doppio Deviatore
di chiusura inferiore con pistone in acciaio.

Serratura di sicurezza a cilindro europeo
a cilindro europeo con 4 pistoni più scrocco.

Cilindro Europeo
con n° 5 chiavi + n° 1 da cantiere + scheda.

Pomolo esterno
in alluminio colore ottone lucido. (optional maniglia girevole)

Maniglia interna
in alluminio colore ottone lucido.

Spioncino grandangolare 200°
in alluminio, colore ottone lucido.

Pannello liscio
interno ed esterno di serie standard

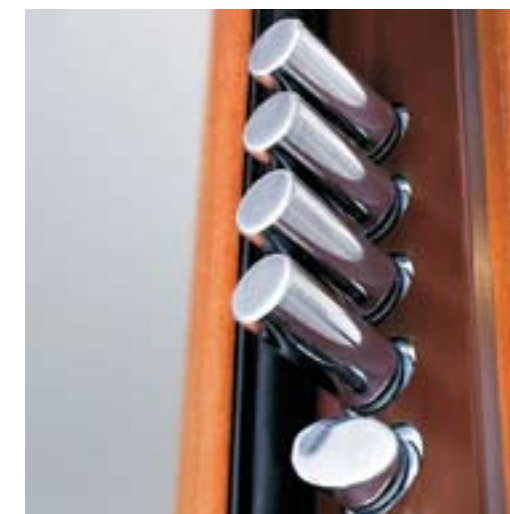

Serratura



kit bronzo



Particolare doppio deviatore

Sortie 2

apertura verso l'esterno

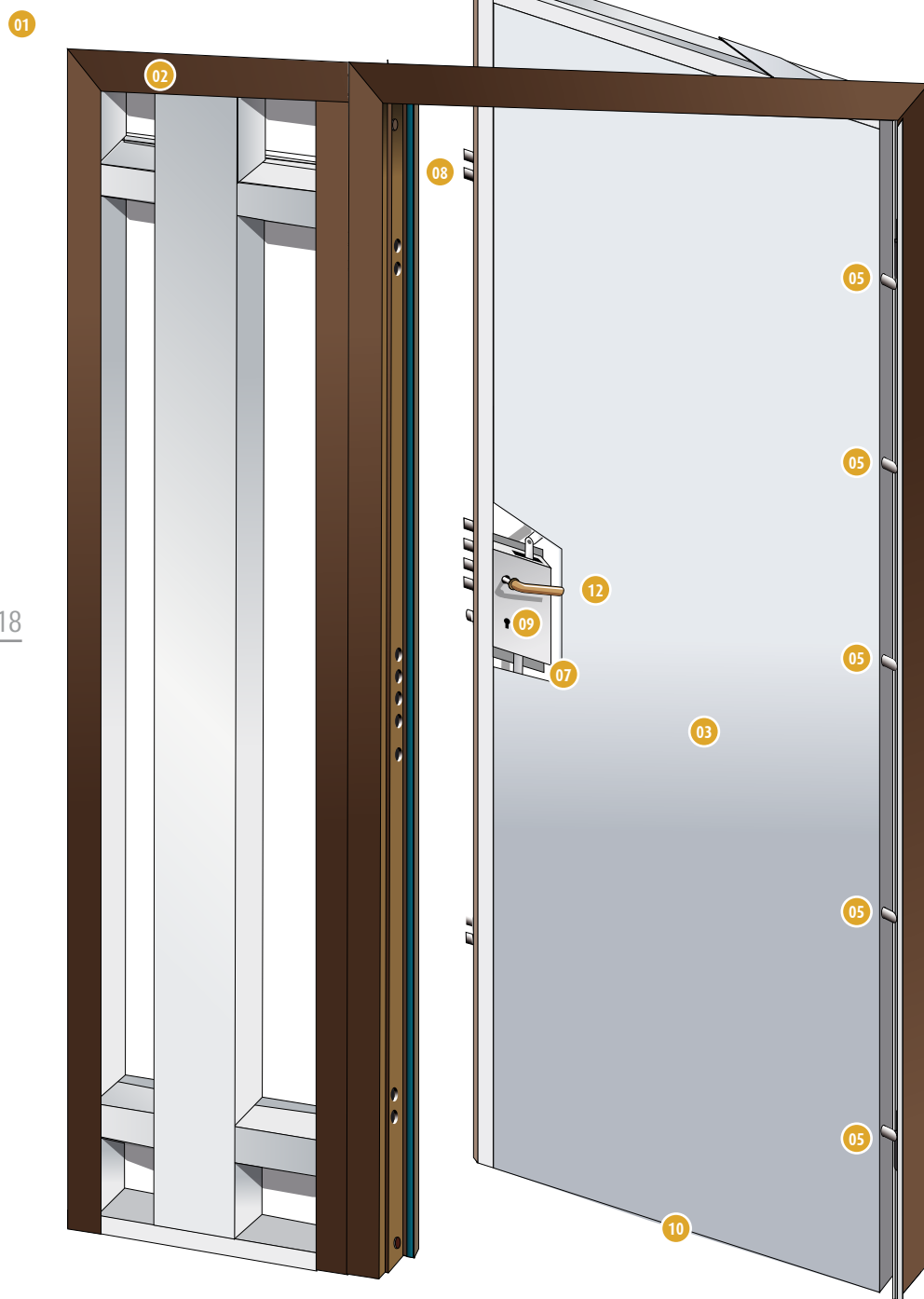

- 1 Falso telaio in lamiera d'acciaio zincato
- 2 Telaio in lamiera d'acciaio plastificato
- 3 Battente in lamiera d'acciaio zincato
- 4 Battente semifisso
- 5 Rostri
- 6 Cerniere
- 7 Piastra
- 8 Doppio deviatore
- 9 Serratura di sicurezza a cilindro europeo
- 10 Soglia mobile paraspifferi
- 11 Pomolo esterno
- 12 Maniglia interna
- 13 Spioncino grandangolare 200°
- 14 Pannello liscio

DIMENSIONI

Luce	Maxingombro falso telaio (Montaggio al contrario)
110 x 210	122,5 x 216,5
115 x 210	127,5 x 216,5
120 x 210	132,5 x 216,5

Disponibile in fuori misura

CARATTERISTICHE TECNICHE E DOTAZIONI DI SERIE

Falso telaio in lamiera d'acciaio zincato
spessore 20/10 con distanziali, n°8 zanche a murare, cavallotti di registrazione e piastre di fissaggio.

Telaio in lamiera d'acciaio plastificato
spessore 20/10 plastificato bifacciale colore testa di moro antiruggine con guarnizione di battuta e pellicola protettiva.

Battente in lamiera d'acciaio zincato
con n° 2 omega centrale verticale di rinforzo, n° 2 omega orizzontali di rinforzo inferiore e superiore per fissaggio cerniere.

Battente semifisso
in lamiera d'acciaio zincato con n° 2 omega centrale verticale di rinforzo, n° 2 omega orizzontali di rinforzo inferiore e superiore per fissaggio cerniere, paletti di chiusura superiore su telaio ed inferiore a pavimento con vaschetta + chiavetta di apertura

Rostrì
n°5, fissi in acciaio lato cerniera

Cerniere
n°2 in acciaio zincato antiruggine, perno a sfera 14x58, gommino a soffiato, copri cerniere in PVC colore testa di moro con tappi, registrabili in H / L.

Piastra
in lamiera d'acciaio 30/10 a protezione serratura.

Doppio Deviatore
di chiusura inferiore con pistone in acciaio.

Serratura di sicurezza a cilindro europeo
a cilindro europeo con 4 pistoni più scrocco.

Cilindro Europeo
con n° 5 chiavi + n° 1 da cantiere + scheda.

Soglia mobile paraspifferi
automatica.

Pomolo esterno
in alluminio colore ottone lucido. (optional maniglia girevole)

Maniglia interna
in alluminio colore ottone lucido.

Spioncino grandangolare 200°
in alluminio, colore ottone lucido.

Pannello liscio
interno ed esterno di serie standard

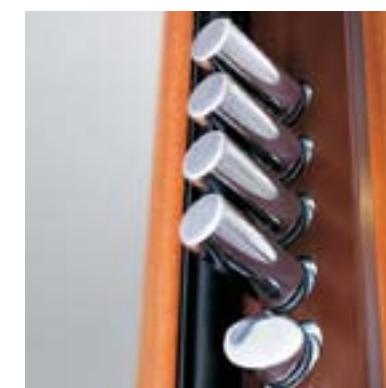

Serratura



kit bronzo



paletti di chiusura



Particolare doppio deviatore

soni

Questa sezione vede in primo piano il legno di okoumè trasformato in pannelli specifici per la lavorazione al pantografo. Una stratificazione speciale per ricercare con assoluta fedeltà l'aspetto del legno massello, mantenendo inalterate le qualità nel tempo.

Per ciò che concerne i laccati, oltre allo stesso pannello di okoumè, produciamo anche pannelli in medium densit idrorepellente che trova anch'esso una buona collocazione all'esterno.

Tutti i nostri pannelli vengono sottoposti ad un trattamento di mordenzatura e di verniciatura all'acqua, prescindendo dalla collocazione finale del prodotto.



linea pantografati



zana



sidi



gery



picasso



24

25

venere

ulisse

roma

novi

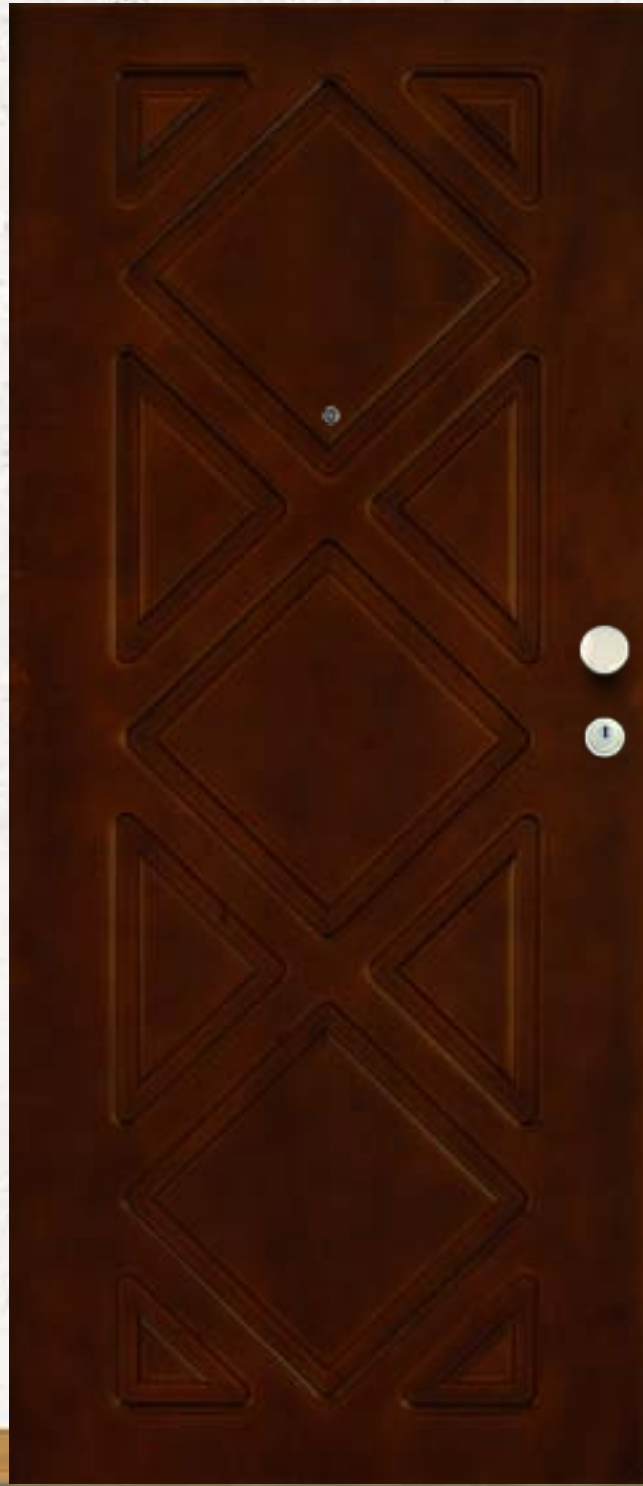

26

27

leonardo

barocco

soni

camel



28

29

mondi

pastel

elios

ocean

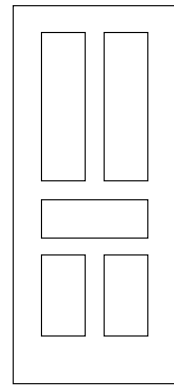

S60

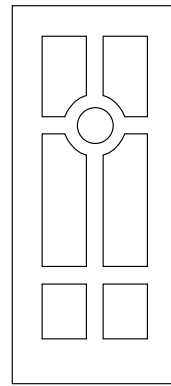

LEONARDO

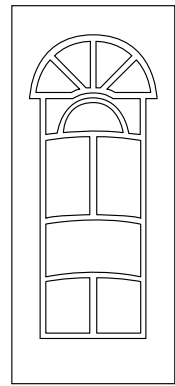

SATURNO

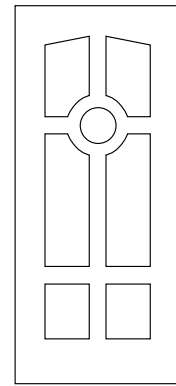

MANI

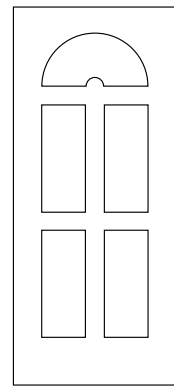

GIOVE

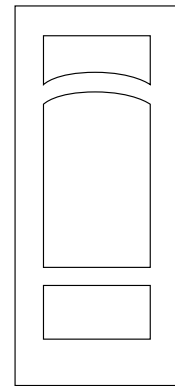

51

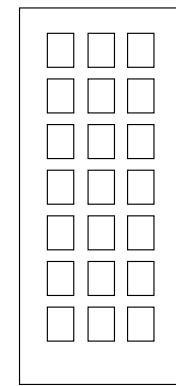

52

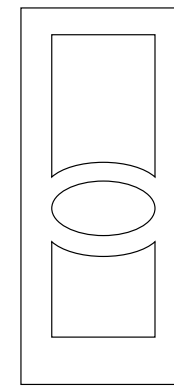

53

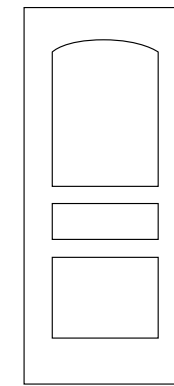

54

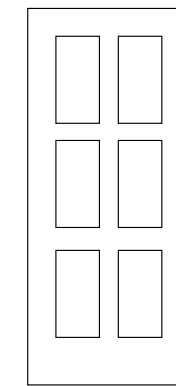

55

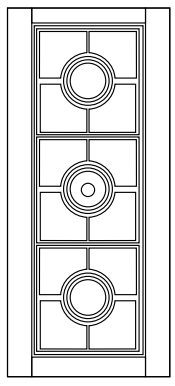

S51

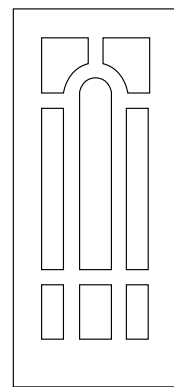

GIUNONE

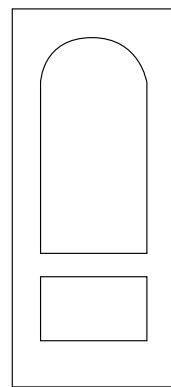

S45

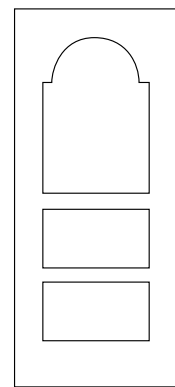

OCRA

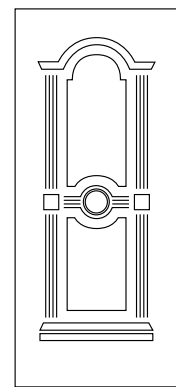

CL93

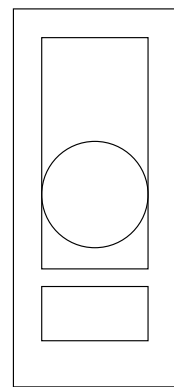

S46

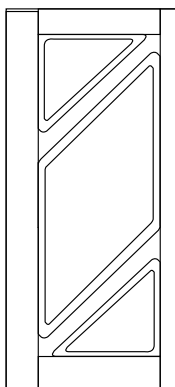

LIDA

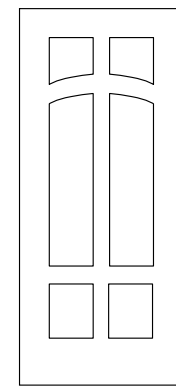

S55

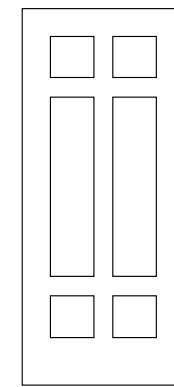

S56

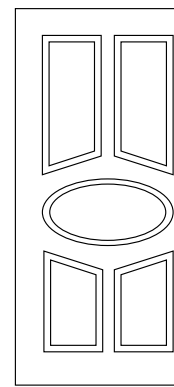

SIDI

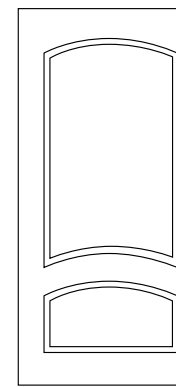

GERY

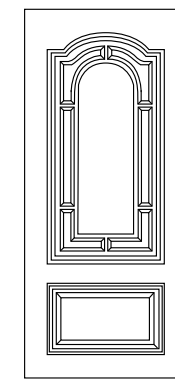

S52

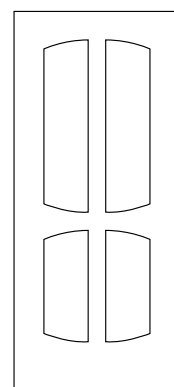

S47

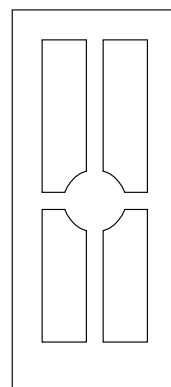

S48

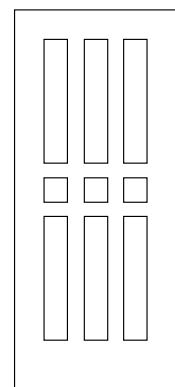

S28

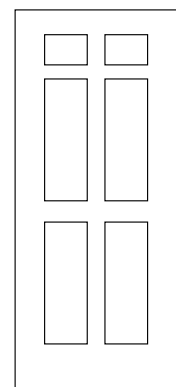

S49

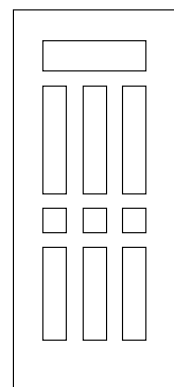

S50

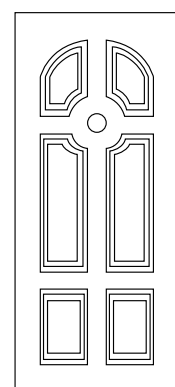

LADY

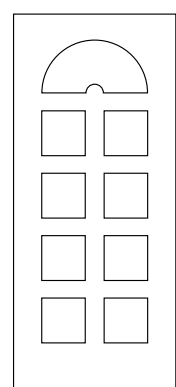

S59

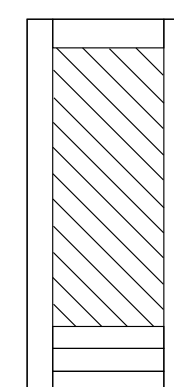

56

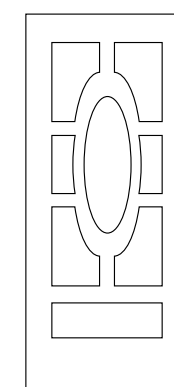

57

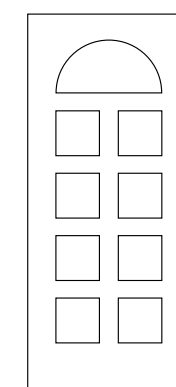

S58

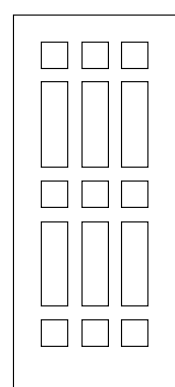

S53

30

31

C 32



linea serigrafati



34

35

ardisia

amandua

brionia

cassia



36

37

clivia

dalia

edera

fragola



38

39

gardenia

geranium

ginestra

iris



40

41

melissa

mandorla

gemma

megan

magnum



linea 3000



gate



evoc



strips



vienna



ciclone



diamante



dolomite



magnum



perla



topazio



vision



titanio



linea alluminio



48

49

c100

c101

c102

c103



burch



amaryllis



haynes



chrysantha



abrud



bath



albona



venezia



carnation



mintha



margaret



hedley



argos



medelpad



pamplona



corinto



carnation



laurence



burch



yola



qoslar



lamaca



spira



plomin



novigrad



wels



celei



oradea



damasco

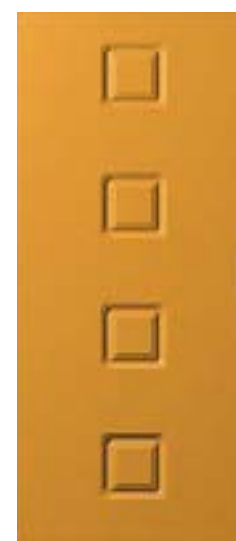

francoforte



marsiglia



amburgo



partia



tegea



kaltiar



viseu



istambul



bucarest



aiaccio



budapest



digne



lamego



trencin



stenbro



valencia



hannover



vigo



odessa



monaco



sofia



ginevra



vienna



creta



costanza



danzica



stettino



cracovia



liverpool



birmingham



cordoba



bratislava



zante



roma



lione



hollis



siena



firenze



bordeaux



salisburgo



madrid



nantes



nizza

giusy



linea massello



mercantile



marzia



marta



hercules

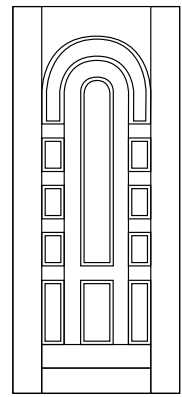

LYRA

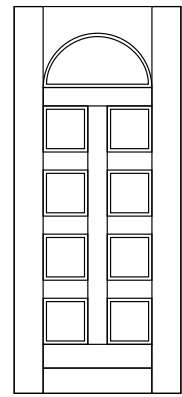

ORION

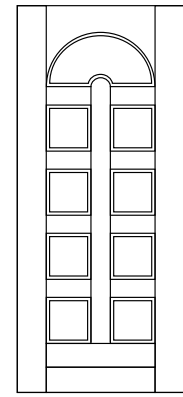

PEGASUS

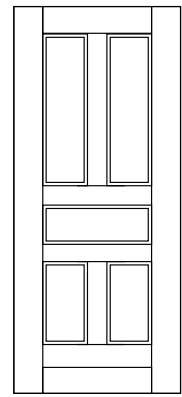

CORONA

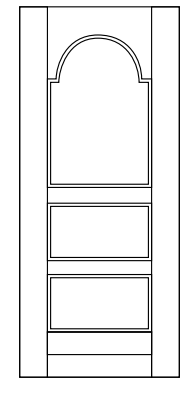

LEO

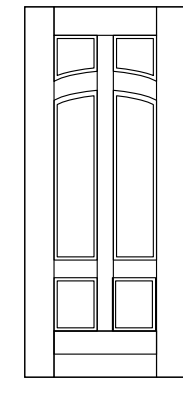

LEPUS

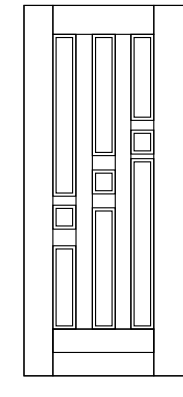

DRAGO

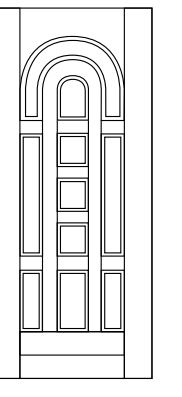

LUPUS

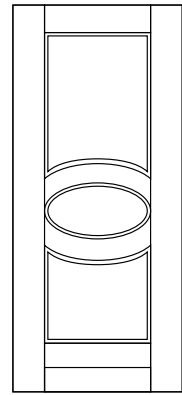

PYXIS

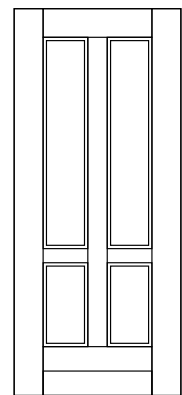

COVUS

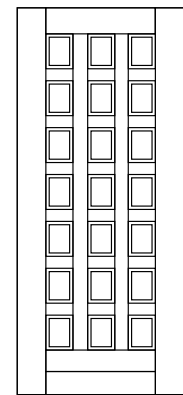

CAPRICORNO

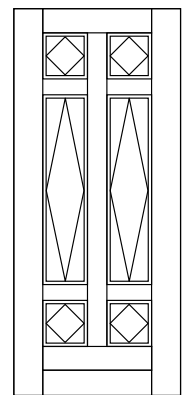

TAURUS

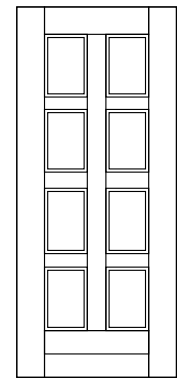

ANTILIA

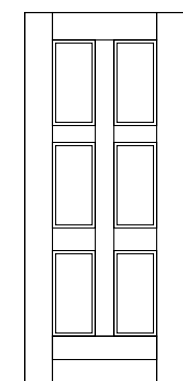

ERIDANS

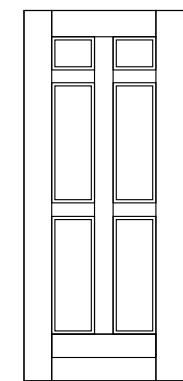

ARIES

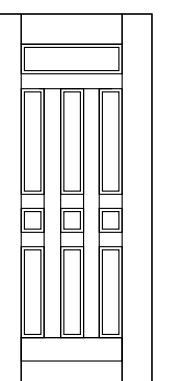

AURIGA

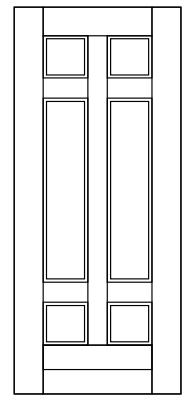

CRATER

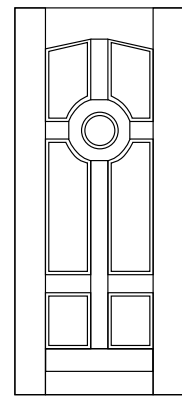

GEMINI

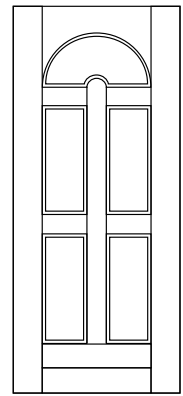

HERCULES

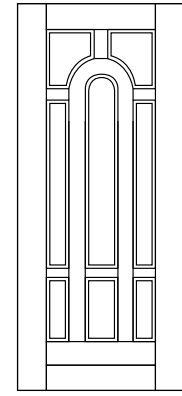

HYDRA

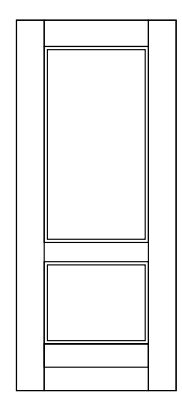

CYGNUS

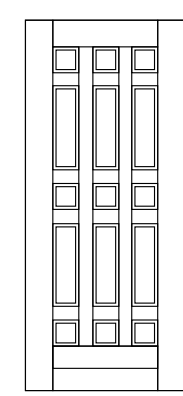

CANES

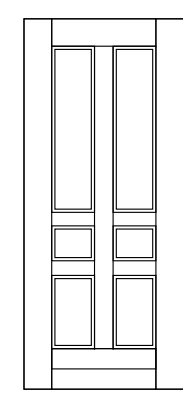

CETUS

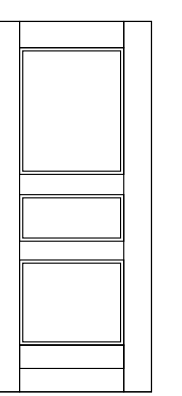

COLUMBA

60

61

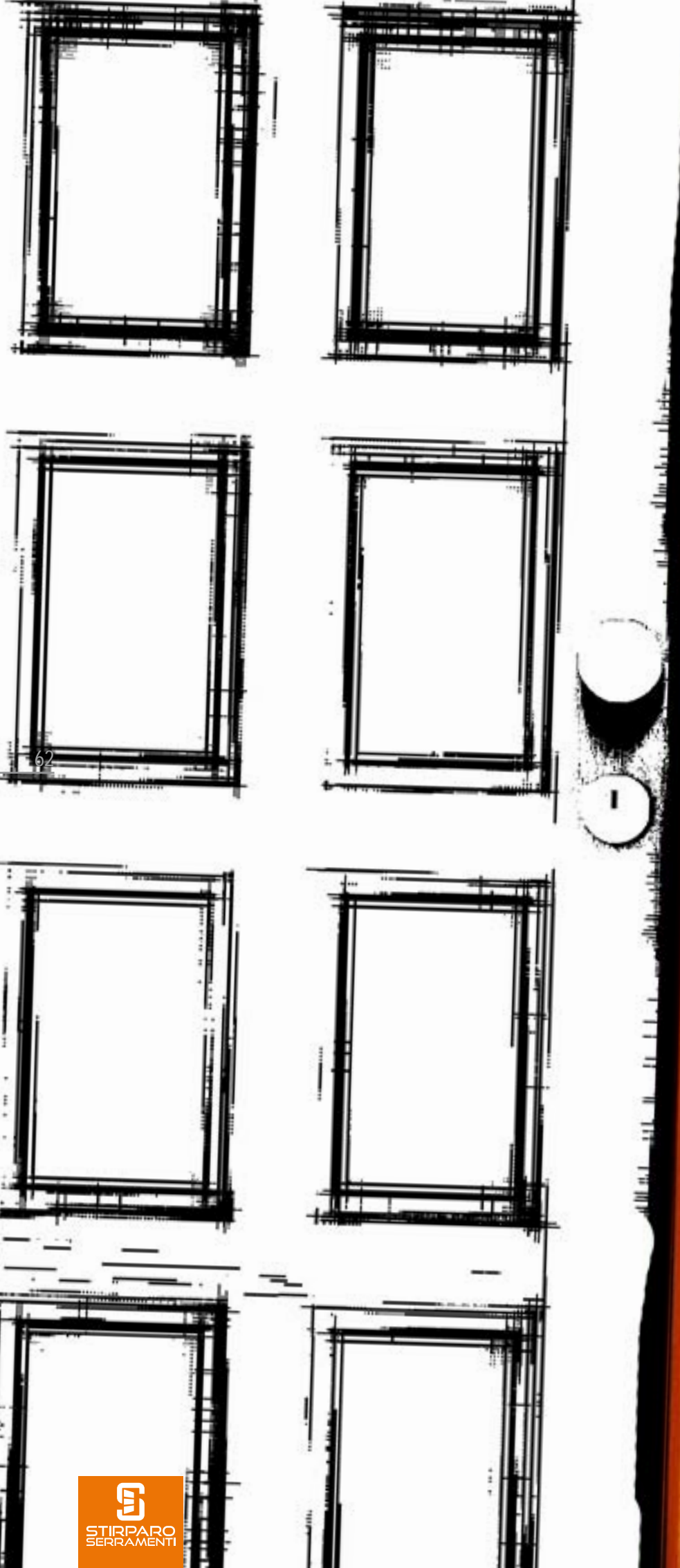

disegni antine

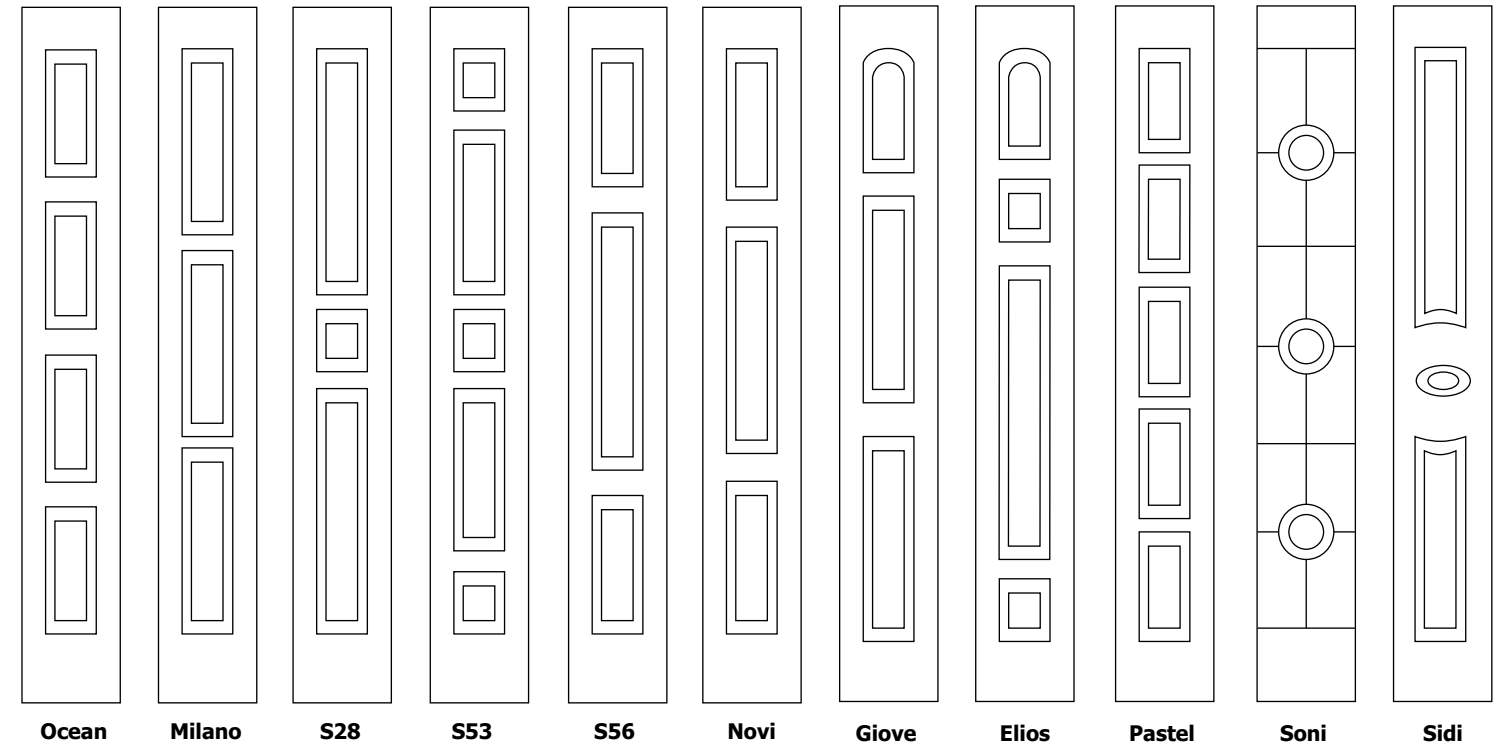

Ocean Milano S28 S53 S56 Novi Giove Elios Pastel Soni Sidi

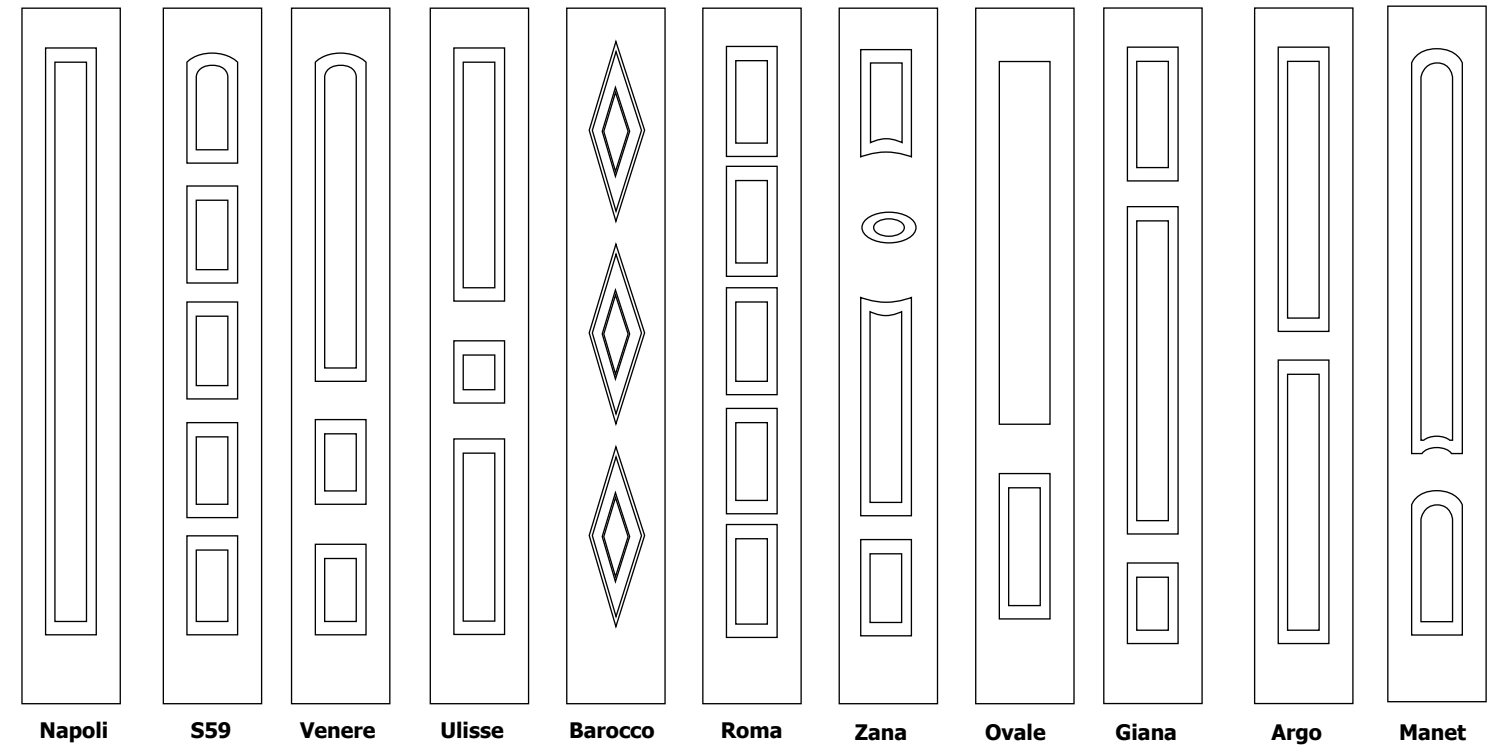

Napoli S59 Venere Ulisse Barocco Roma Zana Ovale Giana Argo Manet

essenze pannelli lisci



mogano

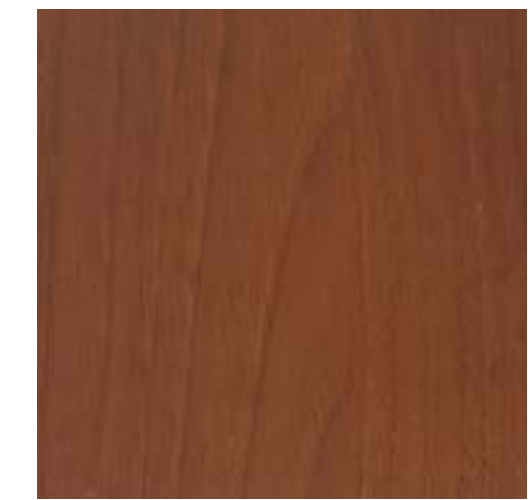

noce medio



rovere



douglas



ciliegio

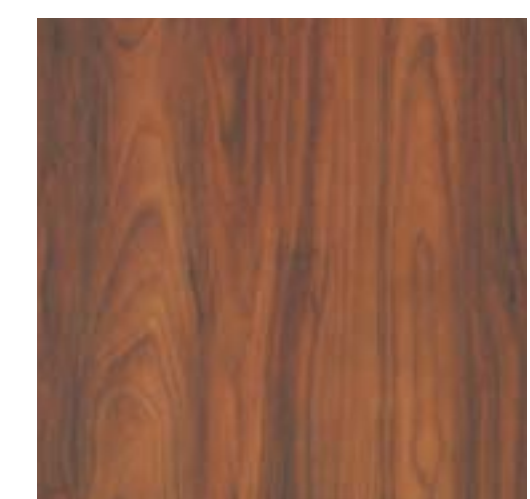

noce nazionale

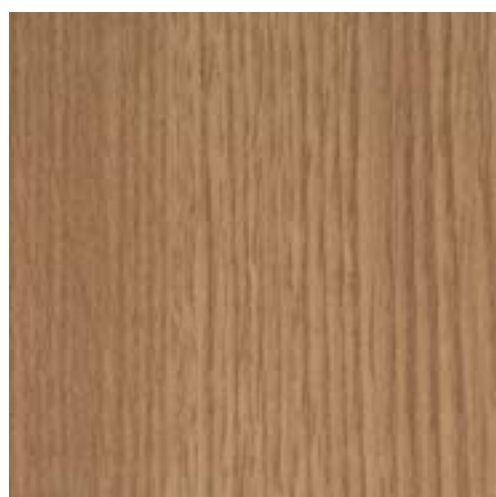

rovere sbiancato

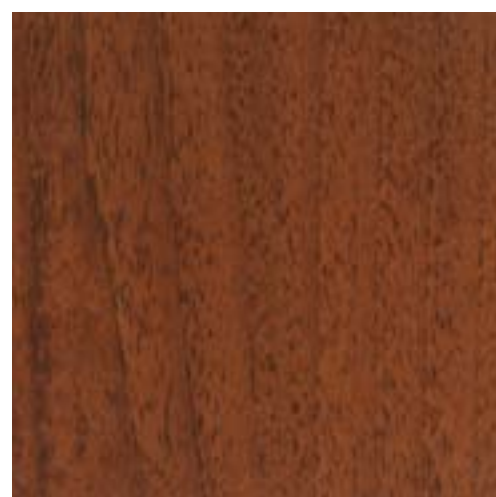

noce scuro

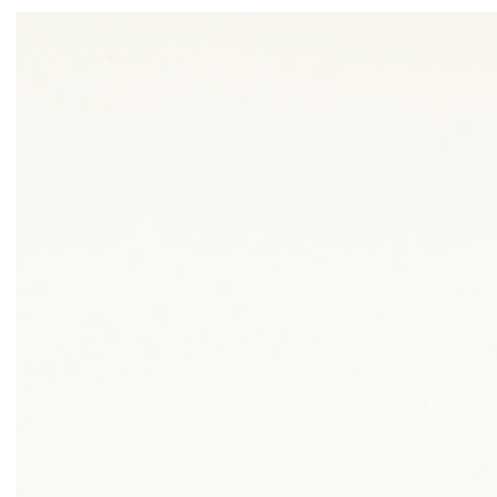

bianco 9010



bianco palissandro

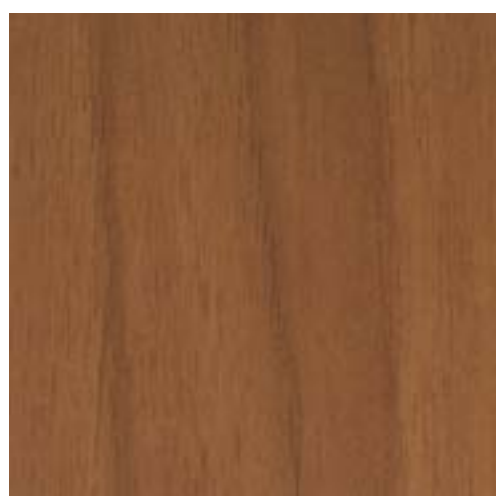

noce chiaro



grigio palissandro



laminato verde 6005

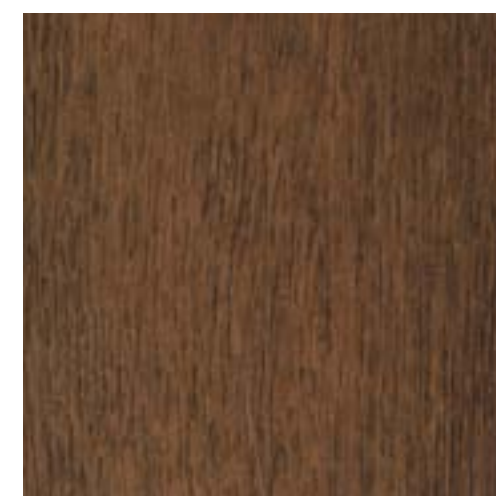

laminato legno



bianco venato



bianco 1013

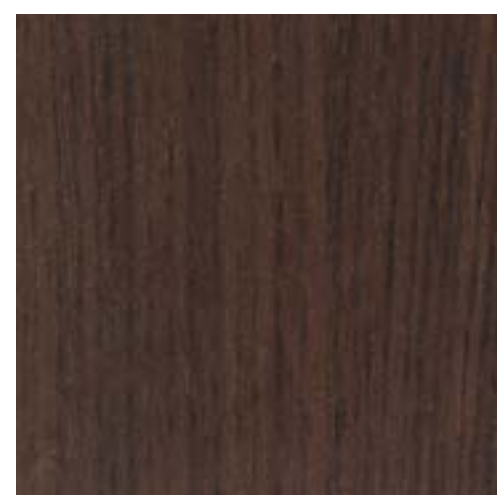

wengè



palissandro blu



rovere sbiancato



bianco palissandro



noce chiaro



grigio palissandro



noce medio



wengè



bianco 9010



noce scuro



rovere



ciliegio

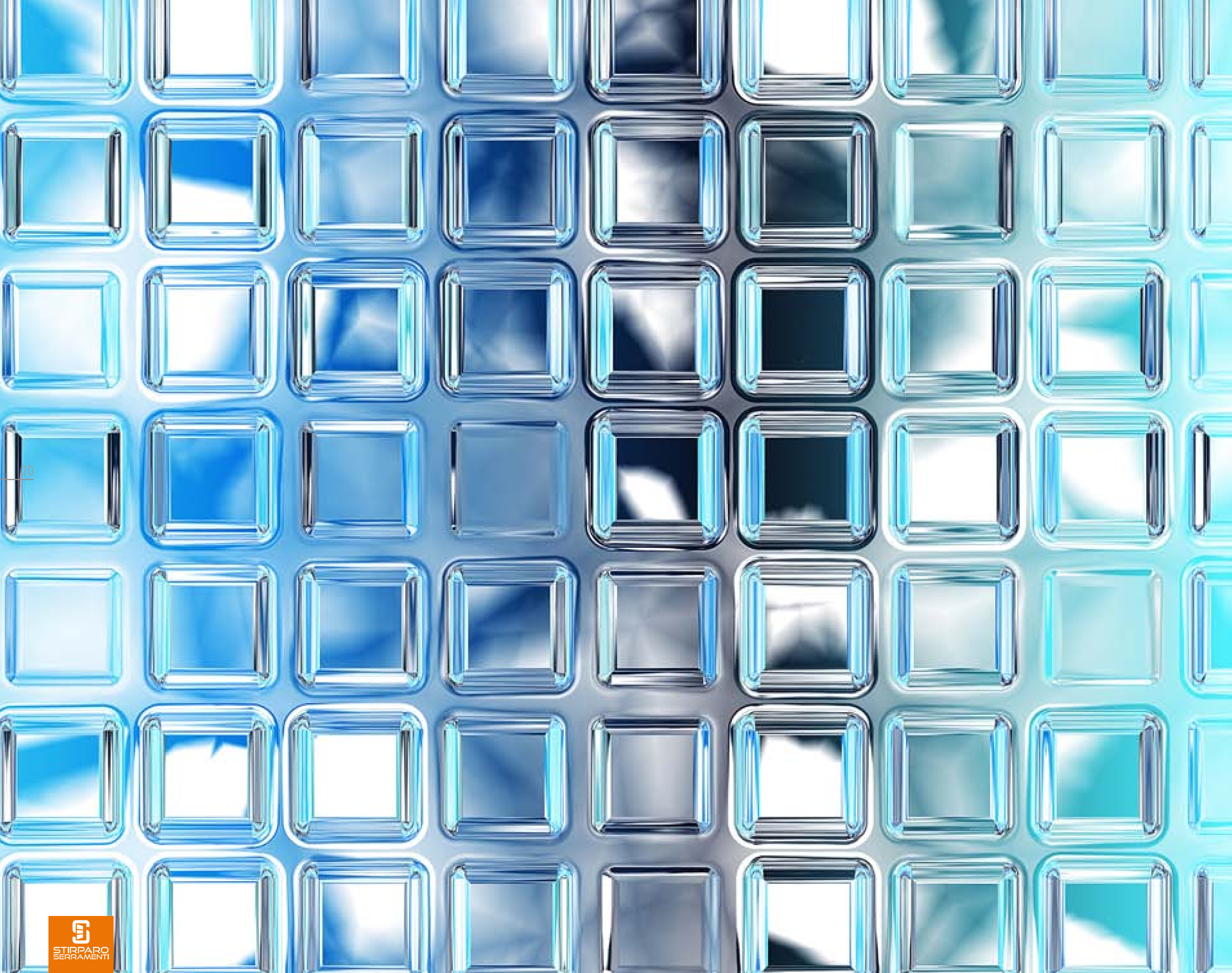

svetratura



C 500



C 501



C 503



C 507



C 508



C 509



C 504



C 505



C 506



C 510



C 511



C 512



Sfinestratura quadrata tipo ULISSE su anta per vetro blindato 18/19



Sfinestratura verticale su antino per vetro blindato 18/19



Sfinestratura sagomata per GEO su anta per vetro blindato 18/19



Sfinestratura superiore mezzaluna tipo GIOVE su anta per vetro blindato 18/19



Sfinestratura verticale ART S70 su anta per vetro blindato 18/19



Doppia sfinestratura verticale ART S72 su anta per vetri blindati 18/19



Sfinestratura superiore mezzaluna ART S74 su anta per vetro blindato 18/19



Doppia sfinestratura verticale su ART S73 su anta per vetri blindati 18/19

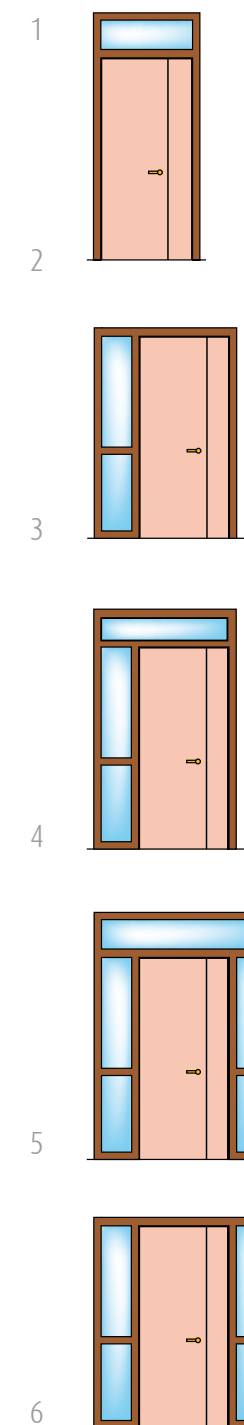
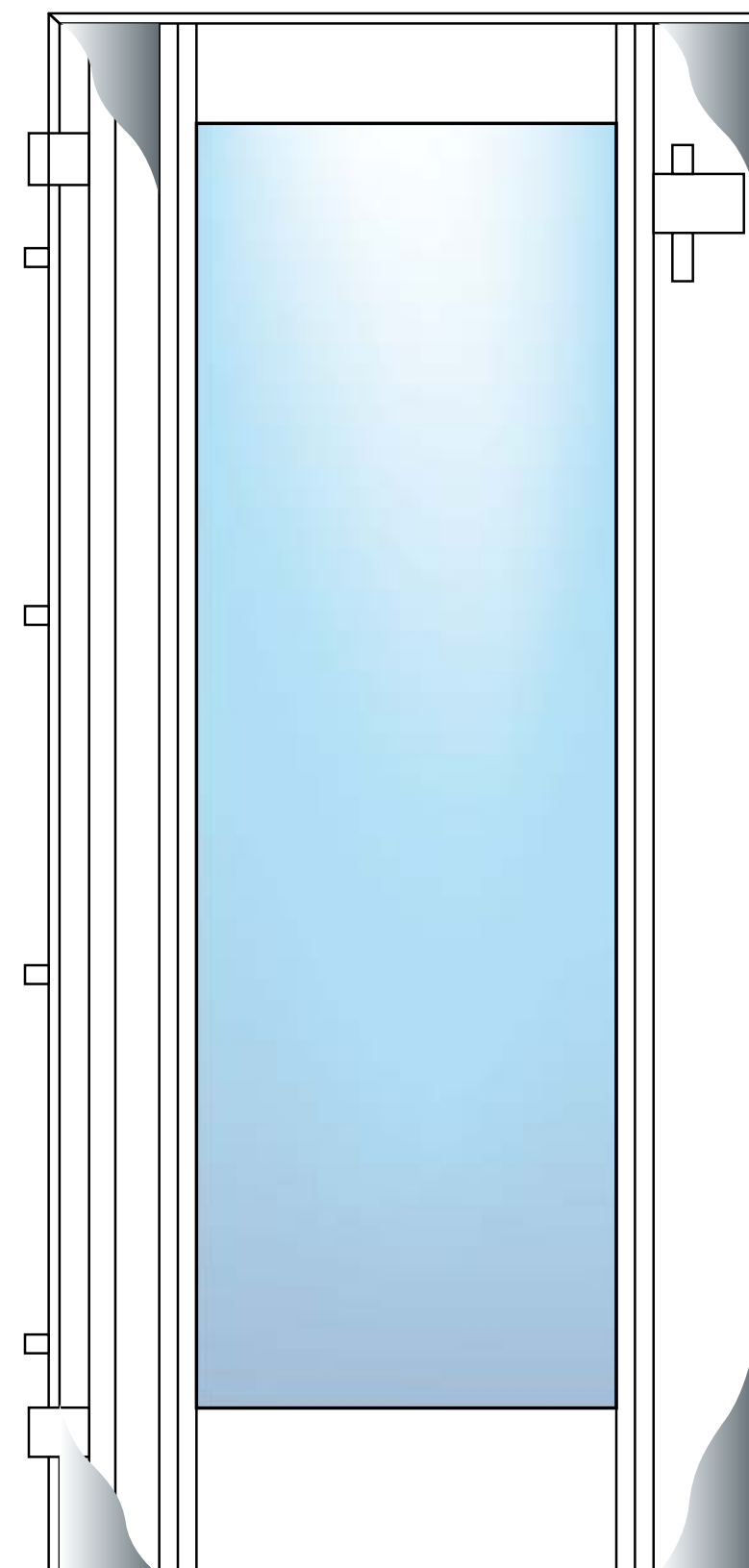



accessori

linea bronzo



linea cromo satinato



78

linea ottone



79

linea bronzo anticata



linea quadra





M 20



M 25



M 21



M 26



M 22



M 27



M 23



M 28



M 24



M 29



serratura a doppio cilindro europeo



serratura a cilindro europeo

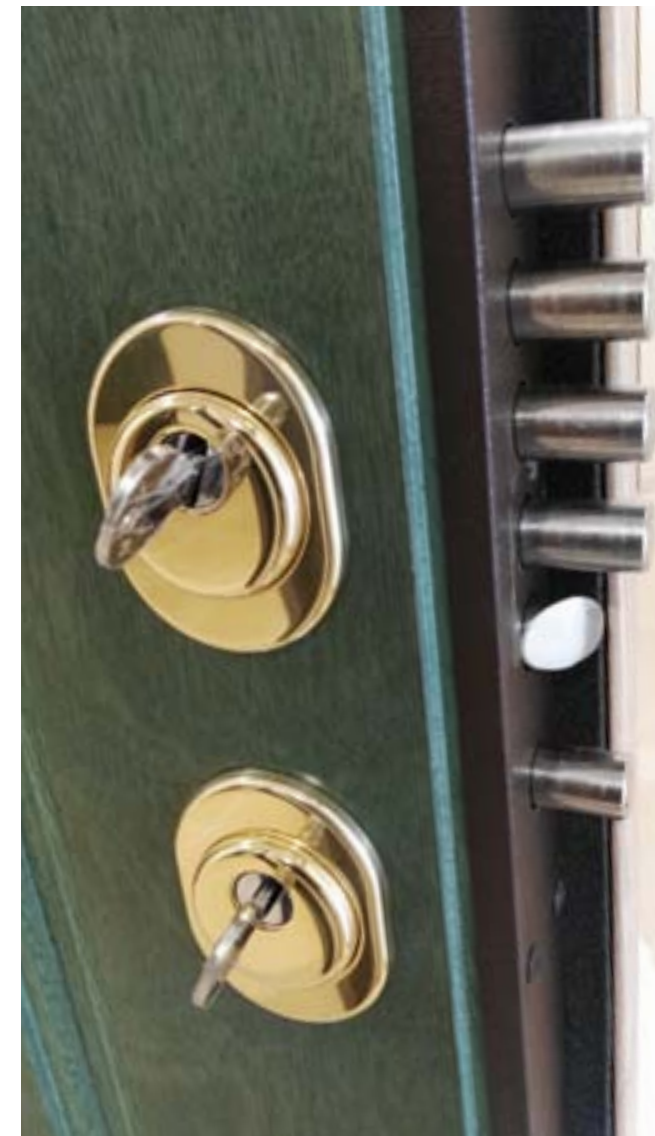

riscontro elettrico



telaio inox
(optional verniciatura RAL)



soglia anti acqua



battenti ad anello



spioncino digitale



maniglione antipanico modello PUSH
(serratura di sicurezza con sblocco mandate)

K22
DUPLICAZIONE
PROTETTA

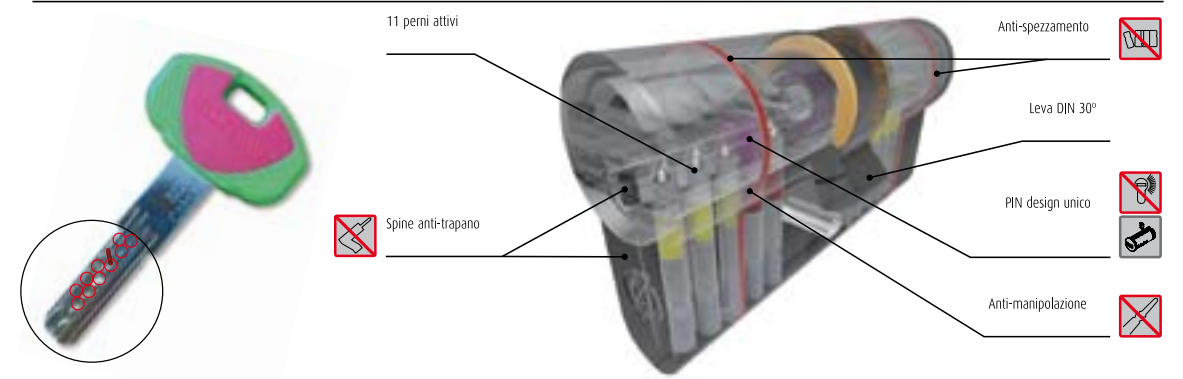

K64
DUPLICAZIONE
PROTETTA

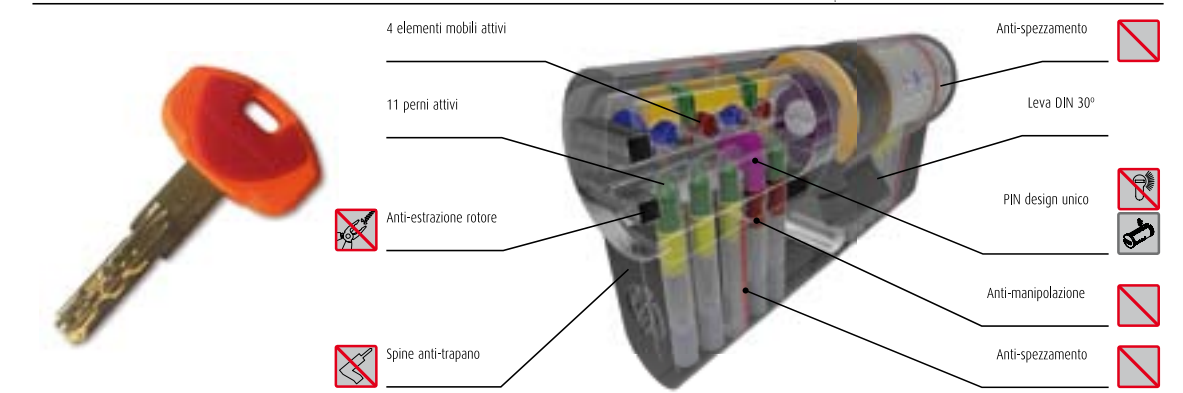

cilindro europeo CISA ap3



cilindro europeo CISA predisposto per pomello interno

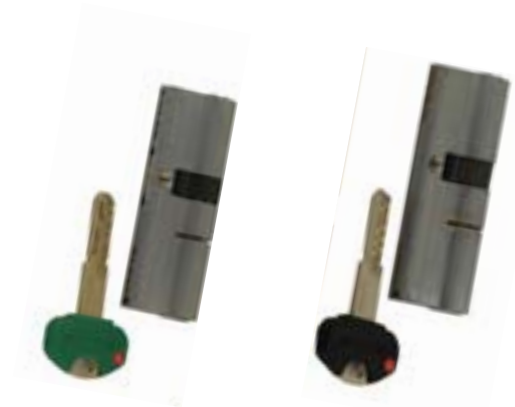

cilindro K3

cilindro K2
di serie



cilindro europeo CISA rs3

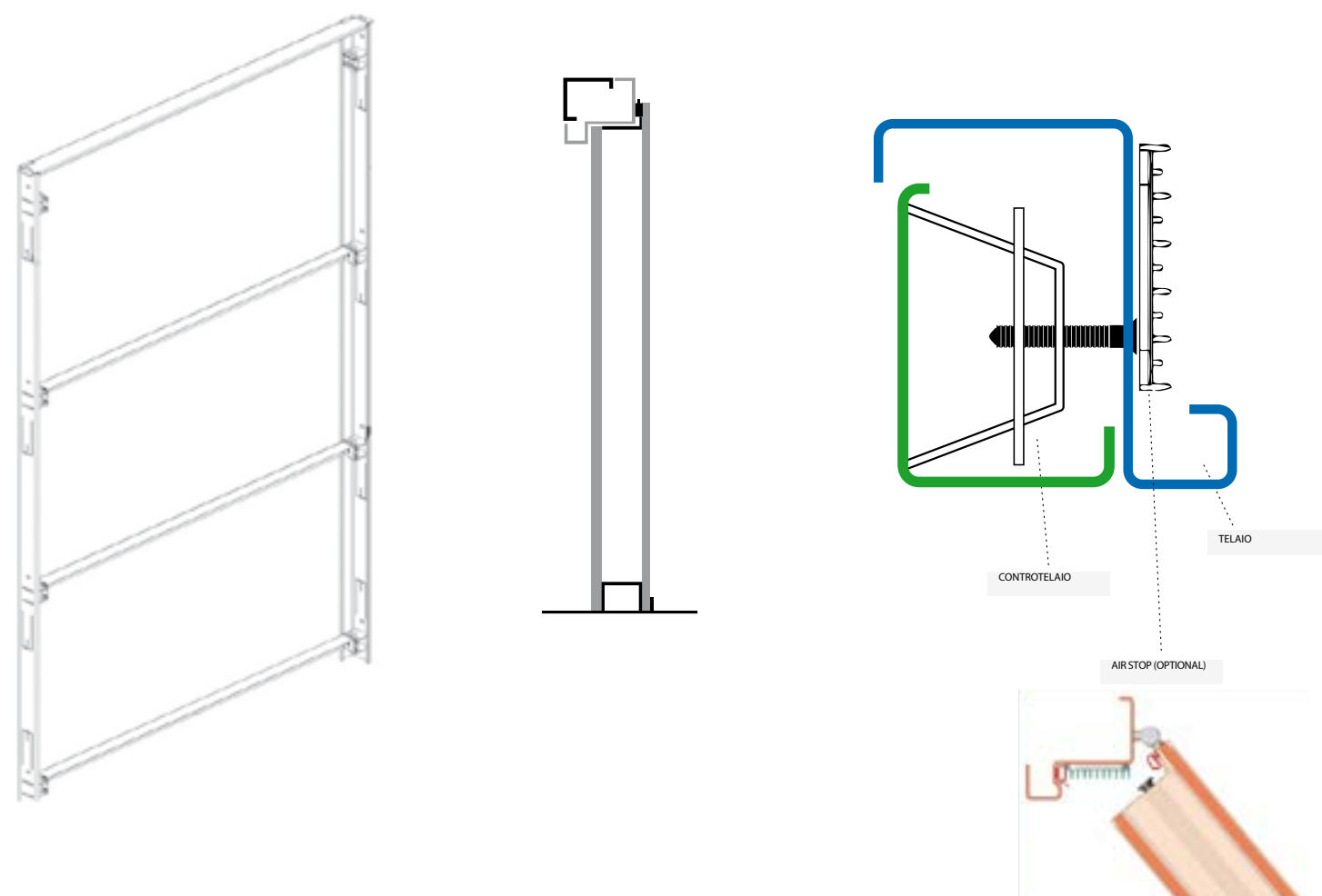

Il perfetto posizionamento del falsotelaio è fondamentale per ottenere una perfetta funzionalità della porta blindata. Pertanto chiediamo di attenervi alle seguenti istruzioni:

1. Avvitare le zanche mediante bulloni al falsotelaio
2. Posizionare il falsotelaio alla parete e tracciare i fori relativi alle zanche.
3. Ricavare i fori tracciati nella parete.
4. Posizionare il falsotelaio sopra la soglia/pavimento e fissarlo perfettamente a piombo.
5. Chiudere i fori con malta cementizia e lasciarla asciugare qualche ora.
6. Rimuovere i distanziali assicurandosi che la malta sia perfettamente asciutta.
7. Non disperdere nell'ambiente i distanziali ma affidarne lo smaltimento ad addetti specializzati.

L'azienda non risponde del malfunzionamento della porta in caso di errato montaggio del falsotelaio.



TABELLA MISURE

Luce netta passaggio	luce esterno falso telaio	Luce massimo ingombro telaio
80x210	92,5x216,5	93,5x216,5
85x210	97,5 x 216,5	98,5x216,5
90x210	102,5 x 216,5	103,5x216,5
110x210	122,5x216,5	123,5x216,5
115x210	127,5x216,5	128,5x216,5
120x210	132,5x216,5	133,5x216,5



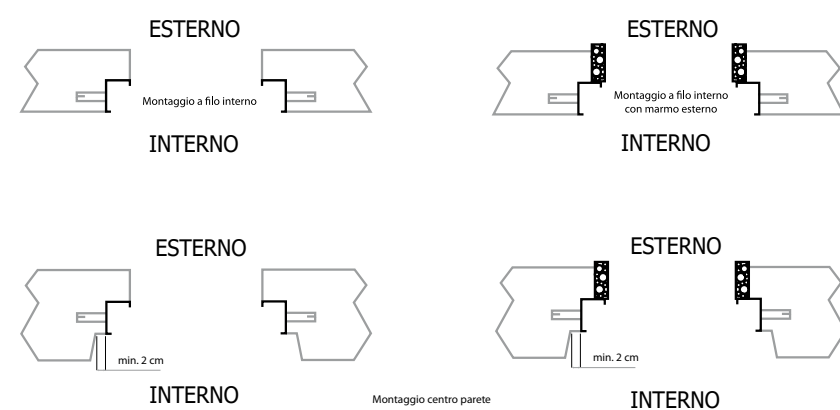
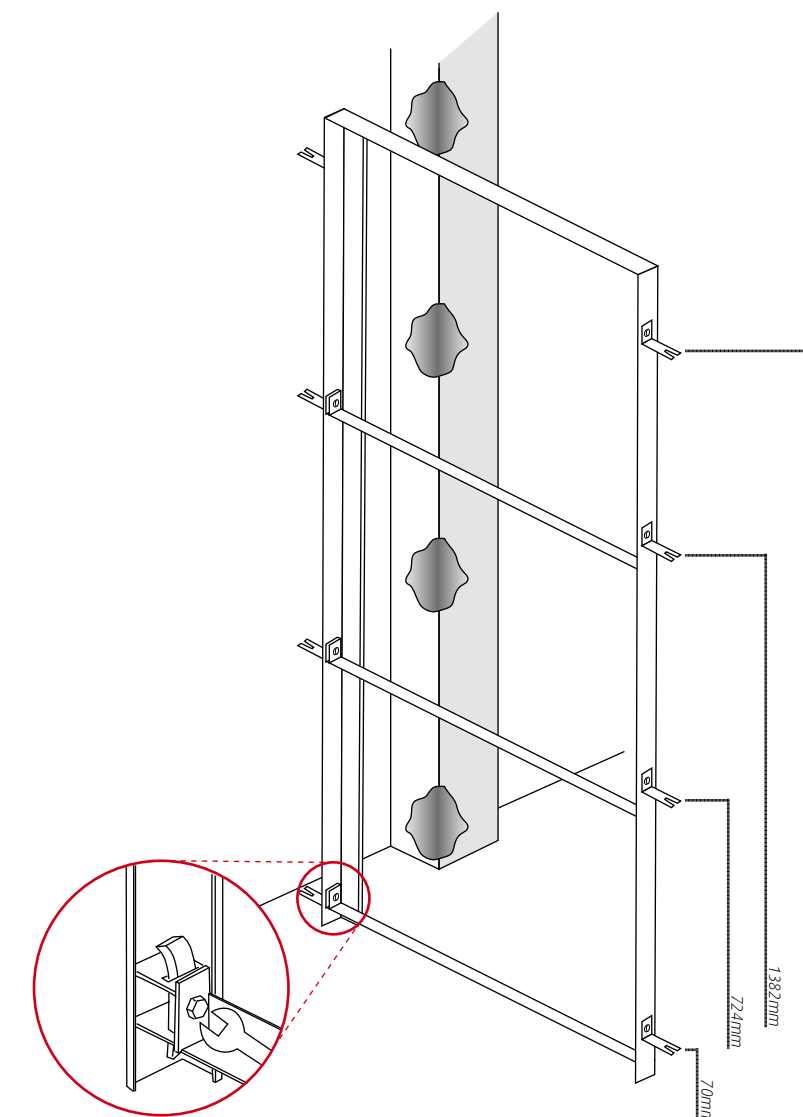
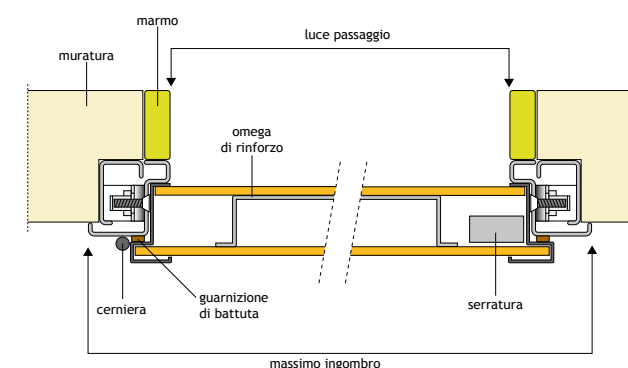
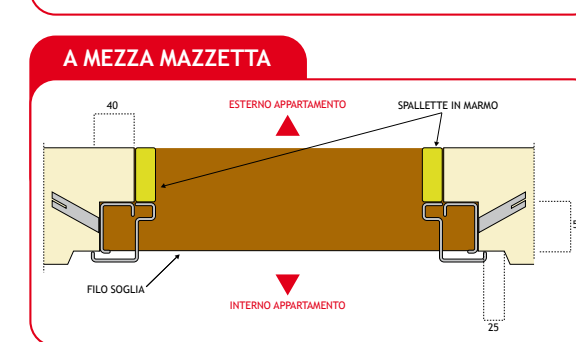
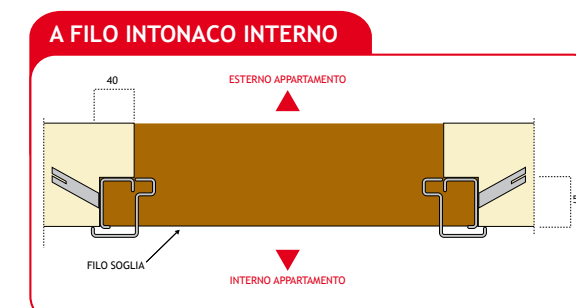
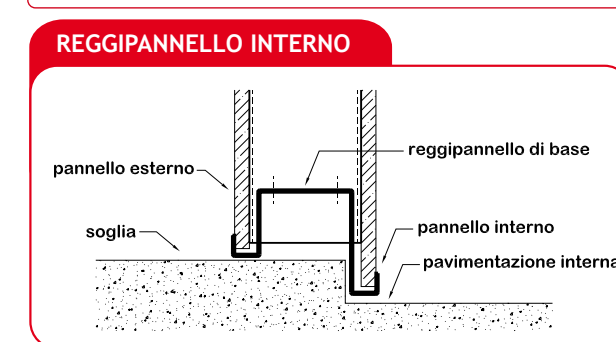
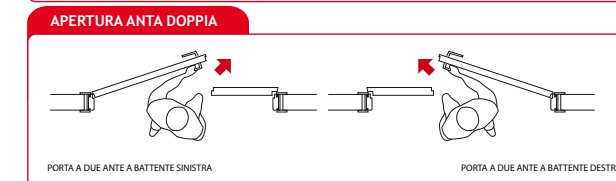
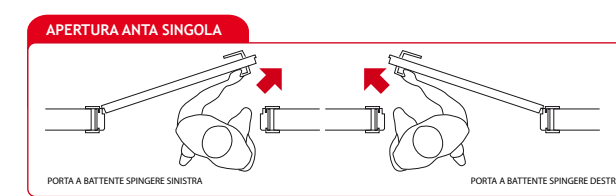

STIRPARO[®]
SERRAMENTI

Stirparo Serramenti S.a.S
di Massimo Stirparo & C.

Loc. Profeta 88050
Caraffa di Catanzaro (cz) Italy
Tel. +39 0961 368052
Fax +39 0961 368038
www.stirparoserramenti.com
info@stirparoserramenti.com